

NAVAL POSTGRADUATE SCHOOL

Monterey, California



A3347

DISSERTATION

OPTIMUM SIGNAL PROCESSING
IN DISTRIBUTED SENSOR SYSTEMS

by
Abdel-Aziz M. Al-Bassiouni
December 1987

Dissertation Supervisor:

Paul H. Moose

Approved for public release; distribution is unlimited.

T238669

REPORT DOCUMENTATION PAGE

1a. REPORT SECURITY CLASSIFICATION <p style="text-align: center; font-size: 1.2em;">Unclassified</p>		1b. RESTRICTIVE MARKINGS									
2a. SECURITY CLASSIFICATION AUTHORITY		3. DISTRIBUTION / AVAILABILITY OF REPORT <p style="text-align: center; font-weight: bold;">Approved for public release; distribution is unlimited.</p>									
2b. DECLASSIFICATION / DOWNGRADING SCHEDULE											
4. PERFORMING ORGANIZATION REPORT NUMBER(S)		5. MONITORING ORGANIZATION REPORT NUMBER(S)									
6a. NAME OF PERFORMING ORGANIZATION <p style="text-align: center;">Naval Postgraduate School</p>	6b. OFFICE SYMBOL <i>(If applicable)</i> <p style="text-align: center;">Code 62</p>	7a. NAME OF MONITORING ORGANIZATION <p style="text-align: center;">Naval Postgraduate School</p>									
6c. ADDRESS (City, State, and ZIP Code) <p style="text-align: center;">Monterey, California 93943-5000</p>		7b. ADDRESS (City, State, and ZIP Code) <p style="text-align: center;">Monterey, California 93943-5000</p>									
8a. NAME OF FUNDING / SPONSORING ORGANIZATION	8b. OFFICE SYMBOL <i>(If applicable)</i>	9. PROCUREMENT INSTRUMENT IDENTIFICATION NUMBER									
8c. ADDRESS (City, State, and ZIP Code)		10. SOURCE OF FUNDING NUMBERS <table border="1" style="width:100%; border-collapse: collapse; margin-top: 5px;"> <tr> <td style="width:25%;">PROGRAM ELEMENT NO.</td> <td style="width:25%;">PROJECT NO.</td> <td style="width:25%;">TASK NO.</td> <td style="width:25%;">WORK UNIT ACCESSION NO.</td> </tr> <tr> <td> </td> <td> </td> <td> </td> <td> </td> </tr> </table>		PROGRAM ELEMENT NO.	PROJECT NO.	TASK NO.	WORK UNIT ACCESSION NO.				
PROGRAM ELEMENT NO.	PROJECT NO.	TASK NO.	WORK UNIT ACCESSION NO.								
11. TITLE (Include Security Classification) <p style="text-align: center; font-weight: bold;">Optimum Signal Processing in Distributed Sensor Systems</p>											
12. PERSONAL AUTHOR(S) <p style="text-align: center;">Abdel-Aziz Mahmoud Al-Bassiouni</p>											
13a. TYPE OF REPORT <p style="text-align: center;">Doctoral Dissertation</p>	13b. TIME COVERED FROM _____ TO _____	14. DATE OF REPORT (Year, Month, Day) <p style="text-align: center;">1987, December</p>	15. PAGE COUNT <p style="text-align: right;">143</p>								
16. SUPPLEMENTARY NOTATION											
17. COSATI CODES <table border="1" style="width:100%; border-collapse: collapse; margin-top: 5px;"> <tr> <th style="width:33%;">FIELD</th> <th style="width:33%;">GROUP</th> <th style="width:33%;">SUB-GROUP</th> </tr> <tr> <td> </td> <td> </td> <td> </td> </tr> </table>		FIELD	GROUP	SUB-GROUP				18. SUBJECT TERMS (Continue on reverse if necessary and identify by block number) <p style="text-align: center;">Quantized Detection; Distributed Sensor Network; Distributed Detection; Data Fusion; Team Decision;</p>			
FIELD	GROUP	SUB-GROUP									
19. ABSTRACT (Continue on reverse if necessary and identify by block number) <p style="margin-top: 20px;">We consider the problem of detection of known signals in noise using quantized, discrete sensor observations. Optimal design of the quantizers at the sensor sites as well as the global fusion of the quantized observations is presented. Also the equivalence between a team of two sensors and their fusion centre and another team of a primary decision maker and a second opinion is shown. Since the fusion of information is a main pillar of the thesis, an early chapter is devoted to the optimum fusion policy. Extension of the results to the case of vector sensor observations is also considered.</p>											
20. DISTRIBUTION / AVAILABILITY OF ABSTRACT <input type="checkbox"/> UNCLASSIFIED/UNLIMITED <input type="checkbox"/> SAME AS RPT <input type="checkbox"/> DTIC USERS		21. ABSTRACT SECURITY CLASSIFICATION									
22a. NAME OF RESPONSIBLE INDIVIDUAL <p style="text-align: center;">Prof. Paul H. Moose</p>		22b. TELEPHONE (Include Area Code) <p style="text-align: center;">(408)-646-2032</p>	22c. OFFICE SYMBOL <p style="text-align: center;">Code 62</p>								

We next consider the problem of minimum mean square estimation of a far away sensor observation from its quantized version and another sensor's observation. It is shown that the optimum quantizer for the sensor signal is the classical Lloyd-Max quantizer.

Examples are given to illustrate the trade off between performance and communications between the sensors. Our results match that of centralized processing at one extreme and that of decentralized processing at the other. The way is graded between extreme ends. Finally a faster algorithm is given to solve the system of nonlinear equations for the optimum system parameters.

Approved for public release; distribution is unlimited.

Optimum Signal Processing in Distributed Sensor Systems

by

Abdel-Aziz Mahmoud Al-Bassiouni

Colonel, Egypt Army

M.Sc., Electrical Engineering, Cairo University, 1981

M.Sc., Applied Mathematics, Naval Postgraduate School, 1987

Submitted in partial fulfillment of the
requirements for the degree of

DOCTOR OF PHILOSOPHY IN ELECTRICAL ENGINEERING

from the

NAVAL POSTGRADUATE SCHOOL

December 1987

Thesis
#3347
c.1

ABSTRACT

We consider the problem of detection of known signals in noise using quantized, discrete sensor observations. Optimal design of the quantizers at the sensor sites as well as the global fusion of the quantized observations is presented. Also the equivalence between a team of two sensors and their fusion centre and another team of a primary decision maker and a second opinion is shown. Since the fusion of information is a main pillar of the thesis, an early chapter is devoted to the optimum fusion policy. Extension of the results to the case of vector sensor observations is also considered.

We next consider the problem of minimum mean square estimation of a far away sensor observation from its quantized version and another sensor's observation. It is shown that the optimum quantizer for the sensor signal is the classical Lloyd-Max quantizer.

Examples are given to illustrate the trade off between performance and communications between the sensors. Our results match that of centralized processing at one extreme and that of decentralized processing at the other. The way is graded between extreme ends. Finally a faster algorithm is given to solve the system of nonlinear equations for the optimum system parameters.

TABLE OF CONTENTS

I.	INTRODUCTION	15
A.	OVERVIEW	15
B.	MOTIVATION	16
	1. The Centralized Detection (CD) Problem	18
	2. The Decentralized Detection (DD) Problem with Fusion	20
C.	THE COMPLEXITY OF THE DD PROBLEM	25
D.	CONTRIBUTIONS OF THIS THESIS	26
E.	ORGANIZATION OF THE THESIS	26
II.	OPTIMUM FUSION OF LOCAL DECISIONS	27
A.	INTRODUCTION	27
	1. Local Decision Optimization	27
	2. Fusion Rule Optimization	27
	3. Global optimization of the Local decisions and the Fusion Rule	28
B.	GLOBAL OPTIMIZATION OF DISTRIBUTED DETECTION	28
	1. 'AND' Fusion	33
	2. 'OR' Fusion	35
	3. Solution of the Nonlinear Threshold Equations	35
	4. Numerical Results	36
C.	THE EFFECT OF CORRELATION BETWEEN SENSOR OBSERVATIONS	39
D.	NUMERICAL RESULTS	46
E.	DISCUSSION AND CONCLUSIONS	55
III.	DETECTION USING QUANTIZED SENSOR OBSERVATIONS	57
A.	INTRODUCTION	57
B.	TEAM DECISION OF A PRIMARY DECISION MAKER AND A SECOND OPINION QUANTIZER.	57

	1. Formulation of the PDM Problem	57
	2. Problem Analysis	59
	3. Conditionally Independent Observations	61
	4. Solution of the Primary Decision Maker Problem with Independent Sensor Observations and Monotonic Likelihood Ratio	64
	5. The Case of Correlated Observations	65
C.	TEAM DECISION OF TWO QUANTIZERS AND A FUSION CENTER	66
	1. Formulation of the QD problem	66
	2. Problem Analysis and the QD Algorithm	67
	3. An Example: The Known Signal in Gaussian Noise	67
D.	NUMERICAL SOLUTION FOR THE SYSTEM PARAMETERS	72
E.	SUMMARY	74
IV.	NUMERICAL RESULTS	75
	A. KNOWN SIGNAL IN GAUSSIAN NOISE	75
	B. SIGNALS WITH EXPONENTIAL DISTRIBUTIONS	82
	C. GAUSSIAN SIGNALS WITH DIFFERENT VARIANCE	83
	D. CONCLUSION	88
V.	THE CASE OF VECTOR OBSERVATIONS	91
	A. INTRODUCTION	91
	B. QUANTIZED DETECTION WITH VECTOR OBSERVATIONS	91
	C. SUMMARY	94
VI.	OPTIMUM ESTIMATION USING QUANTIZED SENSOR OBSERVATIONS	95
	A. INTRODUCTION	95
	B. THE LINEAR MINIMUM MEAN-SQUARE ESTIMATE OF Y_1	95
	C. CONCLUSION	102
	D. GENERALIZATION TO THE VECTOR CASE	102
VII.	SUMMARY, RESULTS, CONCLUSIONS AND SUGGESTIONS FOR FUTURE RESEARCHS	105

A.	SUMMARY	105
B.	RESULTS	106
	1. Detection with Distributed Sensors	106
	2. Minimum Mean Square Estimation in Distributed Sensor Systems	107
C.	CONCLUSIONS	107
D.	SUGGESTIONS FOR FUTURE RESEARCH	108
APPENDIX A:	PROBABILITY OF DETECTION AND PROBABILITY OF FALSE ALARM OF THE PRIMARY DECISION MAKER	109
APPENDIX B:	PROGRAM LISTING TO CALCULATE PARAMETERS OF THE N AND THE (N+1)-LEVEL QUANTIZERS	111
APPENDIX C:	PROGRAM LISTING TO CALCULATE PARAMETERS OF THE TWO QUANTIZERS	114
APPENDIX D:	PROGRAM LISTING TO CALCULATE PARAMETERS OF THE TWO QUANTIZERS FOR THE CASE OF EXPONENTIAL DISTRIBUTIONS	117
APPENDIX E:	PROGRAM LISTING TO CALCULATE PARAMETERS OF THE TWO QUANTIZERS FOR EXAMPLE 3, CHAPTER IV	119
APPENDIX F:	LINEAR MINIMUM MEAN SQUARE ESTIMATE OF Y_1	121
APPENDIX G:	SOLUTION OF THE LLOYD-MAX QUANTIZER PARAMETERS BY THE METHOD OF SUCCESSIVE SUBSTITUTION	123
	1. INTRODUCTION	123
	2. STATEMENT OF THE PROBLEM	123
	3. NUMERICAL RESULTS.	125
	4. PROGRAM LISTING TO CALCULATE THE LLOYD- MAX QUANTIZER PARAMETERS	134
	LIST OF REFERENCES	136
	INITIAL DISTRIBUTION LIST	140

LIST OF TABLES

1. EXHAUSTIVE FUSION LIST OF TWO DECISIONS	32
2. MINIMUM MEAN SQUARE ERROR VS. THE NUMBER OF QUANTIZATION LEVELS	101
3. COMPARISON OF THE AVERAGE NUMBER OF BITS IN THE MMSE AND THE MOE SYSTEMS	101
4. MAX'S QUANTIZER PARAMETERS FOR THE NORMAL DISTRIBUTION	126

LIST OF FIGURES

1.1	Centralized Detection	19
1.2	Decentralized Detection with Fusion	21
2.1	Decision Rules	31
2.2	Ratio of Costs of AND and OR Fusion Rules $a_1 = 1.7, a_2 = 2.3$	37
2.3	ROC Curves of AND and OR Fusion Rules $a_1 = 1.7, a_2 = 2.3$	38
2.4	Ratio of Costs of AND and OR Fusion Rules $a_1 = 1, a_2 = 2$	40
2.5	ROC for AND and OR Fusion Rules $a_1 = 1, a_2 = 2$	41
2.6	Optimum T_1 and T_2 for $\rho \geq a_1 / a_2$	44
2.7	Centralized Threshold Line For Different Values of ρ	45
2.8	Average Decision Costs for Equal SNRs, $C = 1$	47
2.9	Threshold Value for Equal SNRs, $C = 1$	48
2.10	Average Decision Costs for Equal SNRs, $C = 10$	49
2.11	Threshold Value for Equal SNRs, $C = 10$	50
2.12	Average Decision Costs for Unequal SNRs, $C = 1$	51
2.13	Threshold Value for Unequal SNRs, $C = 1$	52
2.14	Average Decision Costs for Unequal SNRs, $C = 10$	53
2.15	Threshold Value for Unequal SNRs, $C = 10$	54
3.1	Configuration A, The Primary Decision Maker and its Quantized Consultant	58
3.2	Configuration B, The Team of Two Quantizers and a Fusion Center	68
3.3	Quantized Threshold Curve	69
3.4	Possible Approximations of the Threshold Equation	73
4.1	ROC Curves for Configuration A , Configuration B and CD	78
4.2	ROC Curves for Configuration A for $\rho = 0$ and 0.25	79
4.3	Average Detection Cost for Configuration B and CD	80
4.4	Average detection cost for Configuration B vs. N	81
4.5	Approximation of the Threshold equation for Different Values of N , for Exponential Signals	84

4.6	ROC curves for Exponential Signals	85
4.7	Average Detection Cost for Different Values of N for Exponential Signals	86
4.8	Possible Approximation Of the Threshold Equation	89
4.9	Average Detection Cost	90
5.1	Vector Observations	92
6.1	Estimation Using Quantized Sensor Observations	96
6.2	Relative Mean Square Estimation Error vs. ω	99

LIST OF SYMBOLS

CD	Centralized Detection
C_{ij}	Cost of detecting H_i while H_j is true
CSP	Centralized Signal Processing
DD	Distributed or Decentralized Detection
DDN	Distributed Decision Network
DSN	Distributed Sensor Network
DSP	Distributed Signal Processing
$E\{.\}$	Expectation Operator
$\text{erf}(x)$	The error function given by
	$\text{erf}(x) = \frac{2}{\sqrt{2\pi}} \int_0^x \exp(-u^2/2) du$
$\text{erfc}(x)$	The complement of the error function = $1-\text{erf}(x)$
$f(y)$	Probability density function of x
H	The phenomena to be detected
H_0	The null hypothesis
H_1	The alternative hypothesis
LMMS	Linear Minimum Mean Square
MMS	Minimum Mean Square
P_{di}	Probability of detection of the i_{th} detector
P_{fi}	Probability of false alarm of the i_{th} detector
P_d	Probability of detection of the fusion center
P_f	Probability of false alarm of the fusion center
PDM	Primary Decision Maker
QD	Quantized Detection
Q_i	i_{th} quantizer
R	The average cost of detection, also risk of decision
SNR	Signal-to-noise ratio
$T_{i o}$	Locally optimum threshold of the i_{th} detector
U_i	Decision of detector i
U_o	Decision of the fusion center
$\text{Var}(.)$	Variance

LIST OF SYMBOLS (CONT'D)

Y_i	i_{th} sensor observation
Y_{iq}	Quantized version of y_i
Z_{i0}	Null decision subspace of Detector i
Z_{i1}	Alternative decision subspace of Detector i
α_i	Quantization rule of the i_{th} quantizer
η	Ratio of the powers at the input and output of the quantizer
Φ	The empty set
$\int_{\Psi} dy$	Integral over the set Ψ
$\Lambda_i(x)$	Likelihood ratio of $x = f_i(x/H_1)/f_i(x/H_0)$
ρ	Correlation coefficient
ρ_{cr}	Critical value of ρ
\mathcal{R}	The set of real numbers
$>$	Greater than
\leq	Less than or equal to

DEDICATION

To My Parents

ACKNOWLEDGEMENTS

I would like to express my gratitude to Prof. Paul H. Moose for his guidance and endless help through this work. During the last four years he was a great educator, research guide and friend.

I am very grateful to Distinguished Prof. John M. Wozencraft and Distinguished Prof. Donald P. Gaver for the time they devoted for me and the inlighted discussions I had with each of them.

I am also grateful to Prof. Arthur L. Schoenstadt, Prof. Charles W. Therrien and Prof. Harriett B. Rigas for helping me in my course and research work and as committee members.

I thank Prof. Roberto Cristi for providing me with useful text material on many occasions. Special thanks go to Prof. Donald Trahan, Prof. Carroll Wilde and Prof. Richard Franke for helping me during work for my degree in Mathematics.

During my entire trip to the United States Prof. Richard A. McGonigal was both a sponsor and a friend in need. I am very thankful for him. Larry Frazier deserves many thanks for his help in producing the form of this thesis.

Finally I thank my wife Ibsam, son Ahmed and daughters Lobna and Lamia for being helpful and patient for many years.

I. INTRODUCTION

This thesis deals with detection and estimation using spatially separated sensors. A typical practical situation is a surveillance system [1] in which a large number of sensors monitor some region of space, earth or sea and report their findings to a global processor. The sensors themselves may use thermal, acoustic or infrared effects to form their observations. The global processor performs some processing on the data to come with a decision or for taking actions. Because of many considerations such as bandwidth communication limitations, time delay or because the amount of information is too massive to be processed by a single processor, the processing is carried out on many levels. As an example consider the case of distributed detection. Detection is performed at the sensor level and at the fusion center.

Due to the loss of information in the local processing, the overall performance degrades. However a great communication bandwidth reduction results. If the communication channels can support more information flow, then it is wise to perform "softer" processing at the local level, to send more information to the fusion center, and to use the information available there effectively.

The purpose of this chapter is to define the Distributed Signal Processing (DSP) problem in general and to show some reasons and situations in which it replaces Centralized Signal Processing (CSP) techniques. We then will review the status of the research on Decentralized Detection (DD) problem, one of the basic problems of DSP. Finally the contributions and organization of this thesis are described.

A. OVERVIEW

Classical (Centralized) Signal Processing (CSP) assumes complete availability of all information (signals) at one central processor for processing (decision making, computing, detection, estimation, etc...). While this situation is realistic in some cases, many real world systems are too large for the classical processing to be practically applied. Power systems, detection networks, large manufacturing systems and military organizations are among those systems in which total centralized signal processing is hard to apply. Some of the reasons and considerations for the limitations of CSP are [2,3]:

1. In large systems, each processor has partial information of some credibility. While total information is distributed in the whole system, total centralization of the information at one processor is impractical, inconvenient or expensive due to limitations in the system's communication channels, memory or computation and information capabilities.
2. In some cases, processing speed is a bottleneck. Increasing local processing of the data at each processor and sending processed data to the next level of processors will help relieve the problem.
3. When reliability of the system is of major concern, distributed processing may better tolerate various kinds of equipment failures. Less complex centralized processing is more easily shifted to a new location.
4. In cases when security is a major problem, increasing local processing will decrease the information handled between the processors, so limit any other system's access to the process.
5. As the cost of computation has decreased dramatically relative to the cost of communication, it is advantageous to trade off increased computation for reduced communication. So in Distributed Sensor Networks (DSN) involving geographically distributed sensors that collect data, it may be more economical to locally process the data and send condensed summaries to other processors.

Distributed Signal Processing (DSP), in contrast to CSP, has several processors that cooperate together to best achieve a global task according to some criterion. A basic problem in DSP, which has attracted much attention recently, is the Decentralized Detection (DD) problem (hypothesis testing). The DD problem will be a major concern in this thesis. A summary of its status is given in the following section.

B. MOTIVATION

There has been an increased interest in the DD problem since Tenney and Sandell introduced it in 1981 [5]. They extended the classical Bayesian formulation of the detection problem to distributed environments. Because their work was the pioneering one in DD and because we will refer to it often in this thesis, let us consider it now in some detail together with the Centralized Detection (CD) problem. Also, because detection is dealt with throughout a large portion of this thesis, we will make some remarks about the phenomena to be detected and about detection criterion.

The Phenomena

Consider observing a phenomena H of M possible states in order to determine which of them is true. For $M = 2$, the state H_0 is called the null hypothesis and H_1 the alternative hypothesis. Their probabilities of occurrence

$$P(H_0) = P_0, \quad P(H_1) = P_1 \quad (1.1)$$

are assumed to be known.

The Sensor Observations

The phenomena H is observed by N sensors S_1, S_2, \dots, S_N . The sensor observations are y_1, y_2, \dots, y_N . The sensor observations have known conditional distributions

$$p(y_1, y_2, \dots, y_N / H_0), \quad p(y_1, y_2, \dots, y_N / H_1). \quad (1.2)$$

Detection Criterion

The function of the detection process is to make a decision, U_o , about which state of the phenomena is true. The optimality criterion is a function

$$J: U_o \times H \rightarrow \mathcal{R}, \quad (1.3)$$

that assigns to the event of deciding u_i when H_j is true a real number C_{ij} , $i, j = 0, 1$, called the detection cost, so

$$J(U_o = u_i, H = H_j) = C_{ij}. \quad (1.4)$$

The objective of the decision rule will be to minimize the expected decision cost

$$\min E\{J(u, H)\}. \quad (1.5)$$

An important ratio in our analysis is the constant given by

$$C = \frac{P_0 (C_{10} - C_{00})}{P_1 (C_{01} - C_{11})}. \quad (1.6)$$

Van Trees [6] showed that the average decision cost is given by,

$$R = C_{00} P_0 + C_{01} P_1 + P_0 (C_{01} - C_{11}) P_f - P_1 (C_{01} - C_{11}) P_d \quad (1.7)$$

where P_f and P_d are the probability of false alarm¹ and probability of detection² respectively. At this point we will make the assumptions that

$$C_{01} > C_{11}, \quad (1.8)$$

and

$$C_{10} > C_{00}, \quad (1.9)$$

These assumptions implies that it is more costly to err than to make a correct decision. Equation (1.7) can then be written in the form:

$$R = \left[\frac{C_{00} P_0 + C_{01} P_1}{P_1 (C_{01} - C_{11})} + \frac{P_0 (C_{10} - C_{00})}{P_1 (C_{01} - C_{11})} P_f - P_d \right] P_1 (C_{01} - C_{11}). \quad (1.10)$$

Ignoring positive constants that will not affect our analysis, the average decision cost R is given by

$$R = 1 + C P_f - P_d. \quad (1.11)$$

1. The Centralized Detection (CD) Problem

The problem of centralized binary hypothesis testing can be posed in its most general form as follows. For the structure of Figure 1.1 it is assumed that all sensor observations can be sent to one (central) location for processing. The function of the processor is to map the vector $\underline{y} = [y_1 y_2 \dots y_N]^t$ into the decision space $U_{\text{sub}}(0,1)$

$$U_o: \underline{y} \rightarrow (0,1) \quad (1.12)$$

as follows;

$$U_o = \begin{cases} 0, & H_0 \text{ is declared to have been detected} \\ 1, & H_1 \text{ is declared to have been detected.} \end{cases} \quad (1.13)$$

¹Probability of deciding $U_o = 0$ while H_1 is true

²Probability of deciding $U_o = 1$ while H_1 is true

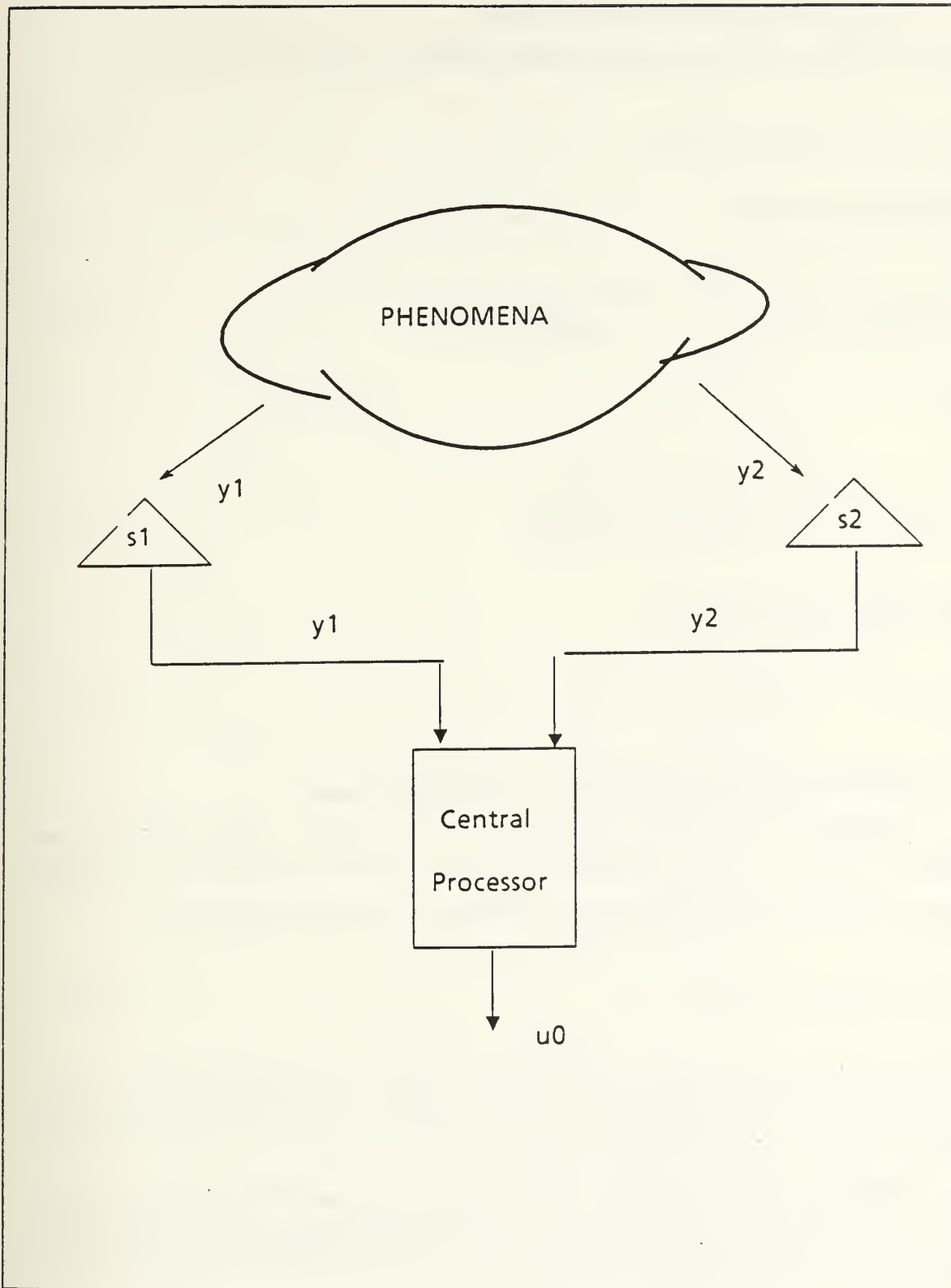

Figure 1.1 Centralized Detection.

Solution of the CD Problem

The solution to the CD problem is [6]

a) deterministic, so that the decision rule is a function of the observations

$$\gamma : Y_1 \times Y_2 \times \dots \times Y_N \rightarrow (0,1), \quad (1.14)$$

b) a likelihood ratio test,

$$U_o(y_1, y_2, \dots, y_N) = \begin{cases} 0, & \text{if } \Lambda(y_1, y_2, \dots, y_N) \geq t \\ 1, & \text{if } \Lambda(y_1, y_2, \dots, y_N) < t \end{cases} \quad (1.15)$$

where

$$\Lambda(y_1, y_2, \dots, y_N) = \frac{f(y_1, y_2, \dots, y_N / H_1)}{f(y_1, y_2, \dots, y_N / H_0)}, \quad (1.16)$$

c) and the threshold t is given by

$$t = C. \quad (1.17)$$

2. The Decentralized Detection (DD) Problem with Fusion

Consider the structure of Figure 1.2 with H and Y being as before; the decisions U_1, U_2, \dots and U_N are sent to a fusion center. The activity of the fusion center is to make the global decision U_o according to some preset fusion rule.

$$U_o : U_1 \times U_2 \times \dots \times U_N \rightarrow (0,1). \quad (1.18)$$

In the DD problem with fusion it is required to design local decision rules U_1, U_2, \dots and U_N and a global fusion rule (1.18) so as to minimize the expected cost $E\{J(U_o, H)\}$ incurred by deciding $U_o = i$ when H_j is true.

Choosing an AND fusion rule a priori, Tenney and Sandell solved this problem for $N=2$. They set the decision rule as $U_o = U_1 U_2$ and optimized the local decision rules.

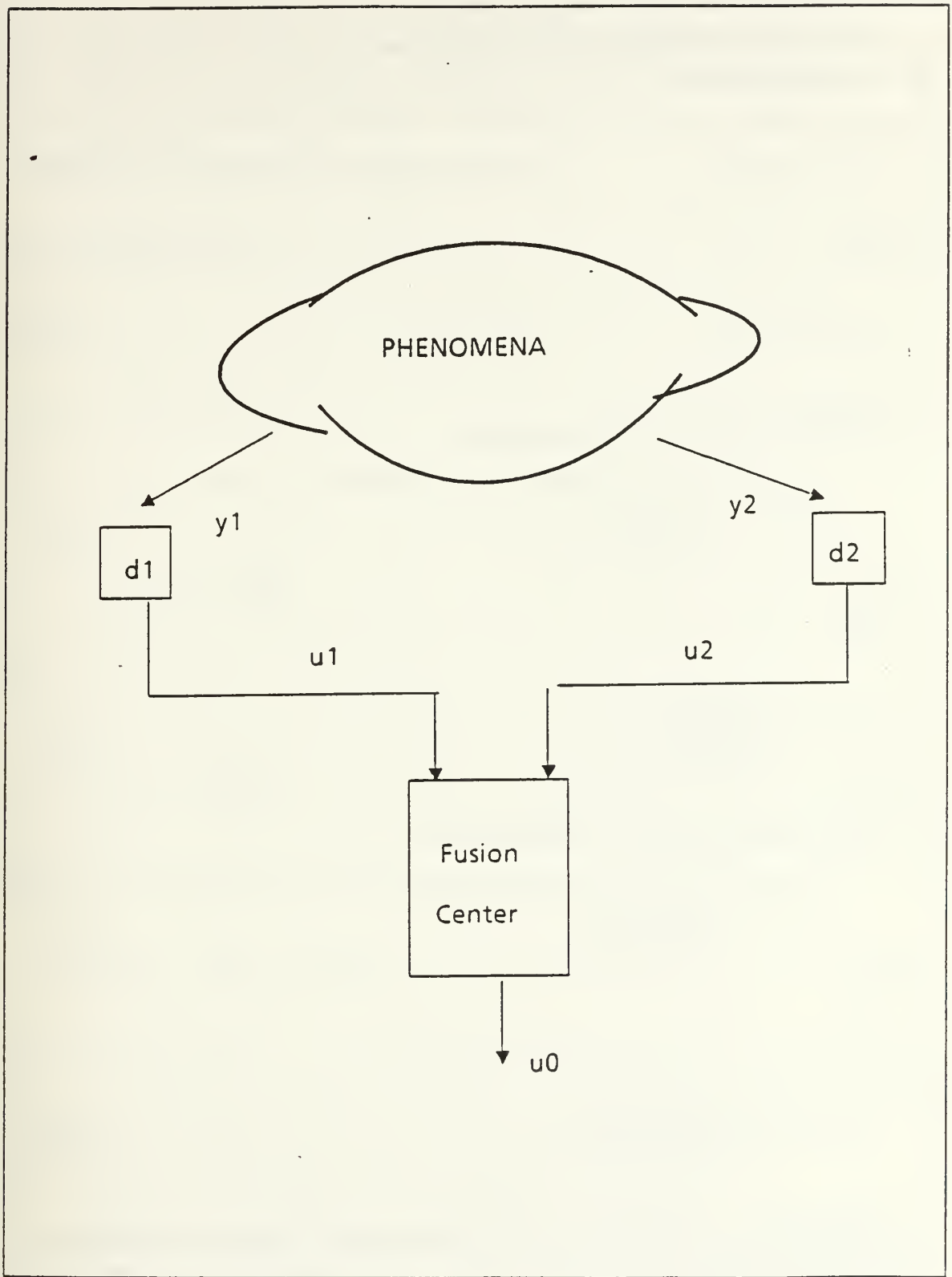

Figure 1.2 Decentralized Detection with Fusion.

Solution of DD Problem with Fusion

The solution to the DD problem with fusion is

1. deterministic

$$\gamma_1 : Y_1 \rightarrow (0,1) \quad (1.19)$$

and

$$\gamma_2 : Y_2 \rightarrow (0,1) \quad (1.20)$$

2. a likelihood ratio test for each detector

$$U_i = \begin{cases} 0, & \text{if } \Lambda_i(y_i) \geq t_i \\ 1, & \text{if } \Lambda_i(y_i) < t_i \end{cases} \quad (1.21)$$

where

$$\Lambda_i(y_i) = \frac{f(y_i / H_1)}{f(y_i / H_0)} \quad (1.22)$$

3. with coupled thresholds t_1 and t_2 given by

$$t_1 = C \frac{\Pr(F_2 / y_1)}{\Pr(D_2 / y_1)} \quad (1.23)$$

and

$$t_2 = C \frac{\Pr(F_1 / y_2)}{\Pr(D_1 / y_2)} \quad (1.24)$$

where $\Pr(F_i / y_j)$ and $\Pr(D_i / y_j)$ are respectively the conditional probability of false alarm and the conditional probability of detection of the i_{th} detector given the j_{th} detector's observation.

Equations (1.23) and (1.24) are two coupled functional equations in t_1 and t_2 . For general distributions, a functional expression for each of them in terms of its own observation and the other detector's decision is impossible. We shall consider the complexity of these decision rules later. A special case of the DD problem is the case of conditionally independent sensor observations, i.e.

$$f(y_1 / y_2 , H) = f(y_1 / H) \quad (1.25)$$

and

$$f(y_2 / y_1 , H) = f(y_2 / H). \quad (1.26)$$

In this case, the conditional probabilities in (1.23) and (1.24) reduce to

$$t_1 = C \frac{P_{f2}}{P_{d2}} \quad (1.27)$$

and

$$t_2 = C \frac{P_{f1}}{P_{d1}} \quad (1.28)$$

Equations (1.27) and (1.28) are two coupled algebraic equations in the form of

$$t_1 = g_1 (t_2) \quad \text{and} \quad t_2 = g_2 (t_1) \quad (1.29)$$

since P_{fi} and P_{di} depend on t_i . This coupling represents cooperation between the two sensors. The threshold equations are necessary conditions for optimality. There may be several local minima; each must be checked to assure the global minima. The threshold equations are strongly coupled for general cost assumptions.

Tenney and Sandell came to the following conclusions:

1. Increasing the signal-to-noise ratio improves the performance of the system. However a centralized system makes more efficient use of the increased information.

2. As the imbalance between the two detectors increases the performance improves. If the signal-to-noise ratio of one of the detectors goes to zero then the system decision is that of the other detector. This is equivalent to the performance of a CD system of the same signal-to-noise ratio.

The case of conditionally independent observations has been considered by many authors. Sarma and Rao [7] extended Tenney and Sandell's results to the case of three sensors. They assumed a majority logic fusion rule and evaluated the threshold settings for some specific cases. Chair and Varshney [8] considered the problem of optimal fusion of N local decisions from prespecified local decision rules. Their optimum fusion structure is a weighted sum of local decisions according to their reliabilities. Reibman and Nolte [9] optimize both local decision rules and the fusion rule under the assumption of identical local decision rules. The global decision is then k out of N . They optimize the local decision rule for each $k, k = 1, 2, \dots, N$, then pick the value of k corresponding to the minimum decision cost.

A sub-class of the DD problem with fusion, that will be referred to as the "Second Opinion" problem, is the fusion of one's observation with another's decisions. An example of this is the second opinion in a medical examination, or even asking for legal advice. Ekchian [10] and Ekchian and Tenney [11] consider some specific topologies of this problem. Each decision maker has to make his decision based on his own observation and a predecessor's decisions. All the decision rules are likelihood ratio tests using the actual data. The thresholds are determined by incoming communication messages. The number of thresholds at each decision maker grows exponentially with the number of message inputs. Their results suggest putting the noisy sensor "up stream" in the detection network.

Papastavrou and Athans [12] also consider the second opinion problem. They examine the structure of a primary decision maker, PDM, and a secondary decision maker, SDM (a consultant). The PDM makes his decision based on his own observation if it is of good quality. If his observation is noisy, the PDM asks, at a communication cost, the opinion of the SDM. Being activated by the request of the PDM, the SDM sends his decision to the PDM or ignores the request if his observation is noisy. In either case the PDM has to make a final decision. Again the thresholds are coupled. The threshold of the PDM is determined by the message of the SDM.

This thesis is motivated mainly by three of the above works namely;

1. Bayesian formulation of the DD problem by Tenney and Sandell [5].

2. Extension of the DD problem to the Distributed Detection Networks by Ekchian. [10]
3. Extension of the DD problem to the case of correlated sensor observations by Lauer and Sandell [4].

C. THE COMPLEXITY OF THE DD PROBLEM

We saw that the DD problem can be solved optimally for conditionally independent sensor observations. If this condition does not hold local decisions are not likelihood ratio tests with constant thresholds. Tenney and Sandell show that for conditionally dependent observations, local decision rules are likelihood ratio tests but with data dependent thresholds (see e.g. (1.23) and (1.24)). These two equations are coupled. This means that the observation of one sensor is necessary for the other sensor's decision, which contradicts the principle of decentralization. In terms of the terminology of the Theory of Combinatorial Complexity [13], Tsitisiklis and Athans [14] show that

1. The DD problem with independent observations is a polynomial time problem.
2. The DD problem with dependent sensor observations in its simplest form is a nondeterministic polynomial NP-complete. This means that exhaustive enumeration is necessary to find the optimum local decision rules. Optimality may be an illusive goal. So, suboptimal solutions must be sought.

A suboptimal solution to the problem for the case of AND fusion was considered by Lauer and Sandell [4]. They considered the case of known signals in correlated noise. They took as a suboptimal solution local decision rules which are likelihood tests but having constant, not data dependent, thresholds satisfying the necessary condition of optimality. These thresholds are given by the implicit equations:

$$\Lambda_1(T_1) = C \frac{\Pr(F_2/T_1)}{\Pr(D_2/T_1)} \quad (1.30)$$

and

$$\Lambda_2(T_2) = C \frac{\Pr(F_1/T_2)}{\Pr(D_1/T_2)} \quad (1.31)$$

D. CONTRIBUTIONS OF THIS THESIS

We have reviewed the complexity of the DD problem and its current status. The research reported here has significantly advanced this status in several important ways. Specifically the contributions of this thesis have been to :

1. Answer the question of the optimum fusion rule at the fusion center for the case of two sensors.
2. Specify the exact relation between the performance of the optimum fusion rule and the correlation coefficient between sensor observations.
3. Solve the the second opinion decision problem.
4. Solve the multi-level DD problem with fusion; i.e. detection with quantized sensor data for the known signal in noise case.
5. Introduce the minimum risk quantizer.
6. Grade the road between DD detection and CD detection.
7. Optimally design quantizers for minimum mean square estimation.
8. Present an efficient procedure to calculate parameters of a large variety of quantizers.

E. ORGANIZATION OF THE THESIS

The thesis is organized as follows. In Chapter II we consider the problem of fusion in DD. Optimum detection with quantized sensor data is considered in Chapter III, where the Quantized Detection algorithm, QD, is introduced. Numerical examples to illustrate the algorithm are given in Chapter IV. Generalization to the case of vector observations is presented in Chapter V. Optimum regeneration of sensor observations from their quantized versions and another sensor observation is considered in Chapter VI. A summary of the thesis, conclusions and suggestions for future research are given in Chapter VII. Proofs to some equations and FORTRAN programs to calculate parameters of the minimum risk and the minimum distortion quantizers are given in the appendices.

II. OPTIMUM FUSION OF LOCAL DECISIONS

In this chapter the important question of the optimum fusion rule will be answered. The relationship of the optimum fusion policy to the ratio of costs and the correlation coefficient between observations is determined.

A. INTRODUCTION

Distributed Detection with fusion is a two level optimization problem. The problem can be formulated in the following three ways:

1. Local Decision Optimization

The first way is to select the fusion rule apriori and optimize the local decision rules accordingly. Setting the activity of the fusion center as AND fusion, Tenney and Sandell [5] derived optimum local decision rules for a pair of spatially separated detectors with conditionally independent observations. They prove that local decision rules are simple likelihood ratio tests with constant thresholds. The thresholds are the solution of a pair of coupled algebraic equations that correspond to the global minimum of the detection cost function. They also show that for the case of correlated observations local decision rules are likelihood ratio tests but with data dependent thresholds. Functional solution of the threshold equations in the later case violates the principle of decentralization. Realizing the difficulty of the problem in the case of correlated observations, Lauer and Sandell [4] designed suboptimal local decisions for AND fusion. Their local decision rules are likelihood ratio tests with constant thresholds satisfying the necessary conditions of optimality. Kovatana [15] considered AND fusion for two detectors. Fefjar [16] compared AND to OR fusion for two detectors. He claimed that OR is better than AND. Stearns [17] contradicts Fefjar's results. He showed by an example that OR combining is better for higher cost of missing the target while AND combining is better for higher cost of false alarms.

2. Fusion Rule Optimization

In the second formulation of the problem, local decision rules are set apriori. Optimization is carried out with respect to the fusion rules. An example of this situation could be factory built sensors that cannot be adjusted. Assuming local threshold settings Chair and Varshney [8] prove that for the case of conditionally independent sensor observations, the optimum fusion rule is a likelihood ratio test that sums local decisions weighted according to their reliability.

3. Global optimization of the Local decisions and the Fusion Rule

The third formulation involves optimization at both levels. Here local decisions are optimized for every possible fusion rule. The optimum fusion rule is the one that minimizes cost.

The main issue of this chapter is the global optimization of the DD system for general correlated observations. First we will state the main results for the case of N conditionally independent and identically distributed sensor observations. Then, the problem of fusing two local decisions of sensors with correlated observations is considered.

B. GLOBAL OPTIMIZATION OF DISTRIBUTED DETECTION

In CD all sensor observations are available at one central processor for detection. The decision rule in CD is a likelihood ratio test in the observations y_1, y_2, \dots, y_N . It declares H_1 is true if the likelihood ratio

$$\Lambda (y_1, y_2, \dots, y_N) \geq C, \quad (2.1)$$

otherwise it will declare H_0 to be true.

In DD only local decisions are sent to the central processor (fusion center). The objective of the fusion center is to mix (fuse) the local decisions into a single global decision with minimum decision cost. So given the local decisions the observation space of the fusion center consists of 2^N discrete points. The activity of the fusion center is to divide this space into two decision regions Z_0 and Z_1 . The decision rule of the fusion center is a likelihood ratio test [8.] The fusion center declares H_1 is true if

$$\Lambda (u_1, u_2, \dots, u_N) \geq C. \quad (2.2)$$

otherwise it will declare that H_0 is true. In the special case of conditionally independent and identically distributed observations, the fusion rule is a k out of N rule. Reibman and Nolte [9] considered this problem. Assuming the same decision rule for every detector they optimize local decisions for every k , $k = 1, 2, \dots, N$ then pick the k with the minimum decision cost.

If sensor observations are not conditionally independent, there is no guarantee that local decisions are simple likelihood ratio tests. The problem turns out to be NP-

complete which needs exhaustive enumerations to find the optimum decision rules [14.] Moreover if sensor observations are not identically distributed, there are as many as 2^{2^N} possible fusion rules for the N sensor decisions. Any algorithm that goes through the entire fusion list optimizing local decisions will be impractical³ for $N \geq 6$.

Our approach to avoid this exhaustive enumeration is the following:

1. We assume that local decisions are likelihood ratio tests with constant thresholds. Again we emphasize that this assumption is valid only for conditionally independent observations, there is no guarantee that it is correct for correlated observations [5]. So the constant threshold likelihood ratio test is optimum for conditionally independent observations and perhaps suboptimum for correlated observations. However the solution tends to the optimum solution as the correlation coefficient tends to zero [4].
2. Those fusion rules which agree with the CD solution will be tested. The rest of the fusion rules will be disregarded. The meaning of this will be made clear in the following example.

Let us consider the case of two sensors ($N = 2$) in detail. To be explicit, consider detection of known signals in gaussian noise. The sensor observations are given by:

$$H_0 : y_i = n_i, \quad i=1,2 \quad (2.3)$$

and

$$H_1 : y_i = a_i + n_i, \quad i=1,2. \quad (2.4)$$

The a_i 's are positive constants and $\underline{N} = [n_1 \ n_2]^t$ is vector of zero mean with covariance

$$K = \begin{bmatrix} 1 & \rho \\ \rho & 1 \end{bmatrix} \quad (2.5)$$

where ρ is given by

$$\rho = E \{ n_1 n_2 \}. \quad (2.6)$$

³A computer that spends 1 μ second in every optimization process, will spend 40000 years to determine the optimum fusion rule, for $N = 6$.

The threshold equation of the CD problem is given by [6],

$$(a_1 - \rho a_2)y_1 + (a_2 - \rho a_1)y_2 = (a_1^2 + a_2^2 - 2\rho a_1 a_2)/2 + (1 - \rho^2)\log(C) \quad (2.7)$$

which is a straight line in the $y_1 y_2$ plane. Figure 2.1 shows decision rules based only on D_1 , only on D_2 , both decision rules together, and the decision rule of CD.

The global optimization requires optimizing local decision rules for every fusion rule then picking the fusion rule with minimum average cost. The observation space of the fusion center consists of four discrete points (0,0), (0,1), (1,0), (1,1). Any fusion rule divides this space into two decision regions Z_1 and Z_0 . There are $2^4 = 16$ methods to subdivide four points into two groups. Table 1 contains a list of those fusion rules.

Some special cases for the detection problem are as follows.

1. If $C_{10} \rightarrow \infty$, i.e. the cost of missing the target is extremely high, the CD solution assigns all the observation space to Z_0 . The fusion center can perform the same. This is fusion rule one.
2. Similarly if $C_{01} \rightarrow \infty$, the fusion center will always decide H_1 , this is fusion rule two.
3. If $a_2 = \rho a_1$, the CD will decide based only on y_1 . So will the fusion center. This is fusion rule three. This can only happen when $a_1 \geq a_2$.
4. If $a_1 = \rho a_2$, the CD will decide based on y_2 . This is fusion rule four. This can only happen when $a_2 \geq a_1$.

The first two situations represent extreme conditions of C . The next two conditions deal with specific values of ρ . We also distinguish the following two cases.

Case a

$$-1 \leq \rho \leq \min(a_1, a_2) / \max(a_1, a_2).$$

In this case the y_1 and y_2 intersections of the threshold equation (2.7) are of the same sign.

Case b

$$\min(a_1, a_2) / \max(a_1, a_2) < \rho \leq 1.$$

In this case the y_1 and y_2 intersections of the threshold equation are of different signs. We shall consider these intervals of ρ when we study the effect of correlation between sensor observations.

The CD threshold in the $y_1 y_2$ plane suggests assigning the decision point (0,0) to Z_0 and (1,1) to Z_1 . The fusion rules from 5 to 14 do not do this. They either assign (0,0) to Z_1 or assign (1,1) to Z_0 or assign (0,0) and (1,1) to the same decision region.

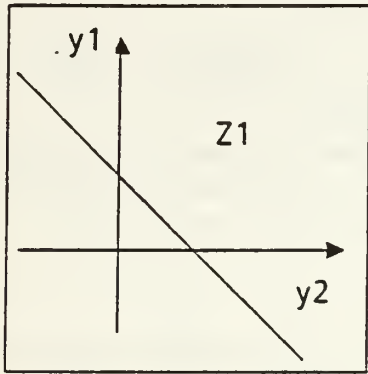

a) Decision rule of CD

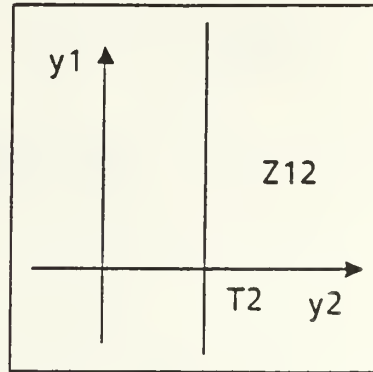

b) Decision rule of D2

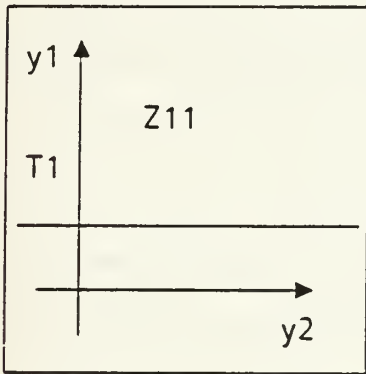

c) Decision rule of D1

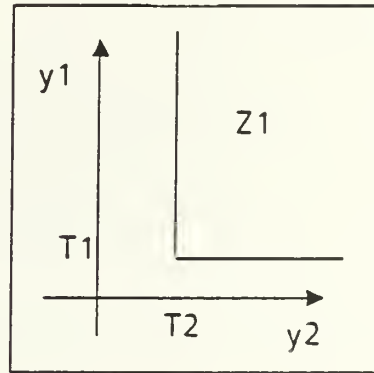

d) Decision rule of AND fusion

Figure 2.1 Decision Rules.

TABLE 1
EXHAUSTIVE FUSION LIST OF TWO DECISIONS

Rule #	Z_0	Z_1	Comments
1	Φ	(0,0),(0,1),(1,0),(1,1)	$C_{01} \rightarrow \infty$
2	(0,0),(1,0),(0,1),(1,1)	Φ	$C_{10} \rightarrow \infty$
3	(0,0),(1,0)	(0,1),(1,1)	$U_0 = U_2$
4	(0,0),(0,1)	(1,0),(1,1)	$U_0 = U_1$
5	(0,1)	(0,0),(1,0),(1,1)	
6	(1,0)	(0,0),(0,1),(1,1)	
7	(1,1)	(0,0),(1,0),(0,1)	
8	(0,1),(1,0)	(0,0),(1,1)	
9	(0,1),(1,1)	(0,0),(1,0)	
10	(1,0),(1,1)	(0,0),(0,1)	
11	(0,0),(1,1)	(0,1),(1,0)	
12	(0,1),(1,0),(1,1)	(0,0)	
13	(0,0),(0,1),(1,1)	(1,0)	
14	(0,0),(1,0),(1,1)	(0,1)	
15	(0,0),(0,1),(1,0)	(1,1)	AND
16	(0,0)	(0,1),(1,0),(1,1)	OR

We will not consider these ten fusion rules further. The remaining two decision rules are the AND fusion and the OR fusion. Let us now consider optimizing each of them.

1. ' AND ' Fusion

In AND fusion u_o is given by:

$$u_o = u_1 u_2. \quad (2.8)$$

The individual rules are given by assigning y_i to Z_1 if

$$y_i \geq T_i \quad ,i=1,2. \quad (2.9)$$

Otherwise they assign it to Z_0 .

The probability of detection $P_d(\text{AND})$ and probability of false alarm $P_f(\text{AND})$ of the fusion center are given by:

$$P_d(\text{AND}) = \int_{T_1}^{\infty} \int_{T_2}^{\infty} f(y_1, y_2 / H_1) dy_1 dy_2 \quad (2.10)$$

and

$$P_f(\text{AND}) = \int_{T_1}^{\infty} \int_{T_2}^{\infty} f(y_1, y_2 / H_0) dy_1 dy_2 \quad (2.11)$$

It has been shown in Chapter I that, to within positive multiplicative and additive constants, the average decision cost is given by

$$R = 1 + C P_f - P_d. \quad (2.12)$$

Substituting for P_d and P_f in (2.12) from (2.10) and (2.11) expresses $R(\text{AND})$ as a function of T_1 and T_2 . The necessary conditions for optimality are

$$\partial R / \partial T_1 = 0 \text{ and } \partial R / \partial T_2 = 0, \quad (2.13)$$

which can be written in the forms:

$$C \int_{T_2}^{\infty} f(T_1, y_2 / H_0) dy_2 = \int_{T_2}^{\infty} f(T_1, y_2 / H_1) dy_2 \quad (2.14)$$

and

$$C \int_{T_1}^{\infty} f(y_1, T_2 / H_0) dy_1 = \int_{T_1}^{\infty} f(y_1, T_2 / H_1) dy_1. \quad (2.15)$$

Applying Bayes rule and rearranging terms, one can write (2.14) and (2.15) as follows:

$$\Lambda_1(T_1) = C \frac{\int_{T_2}^{\infty} f(y_2 / T_1, H_0) dy_2}{\int_{T_2}^{\infty} f(y_2 / T_1, H_1) dy_2} \quad (2.16)$$

and

$$\Lambda_2(T_2) = C \frac{\int_{T_1}^{\infty} f(y_1 / T_2, H_0) dy_1}{\int_{T_1}^{\infty} f(y_1 / T_2, H_1) dy_1}. \quad (2.17)$$

To insure minima the Hessian matrix of R with respect to T_1 and T_2

$$(2.18)$$

$$H = \begin{bmatrix} \partial^2 R / \partial T_1^2 & \partial^2 R / \partial T_1 \partial T_2 \\ \partial^2 R / \partial T_2 \partial T_1 & \partial^2 R / \partial T_2^2 \end{bmatrix} \quad (2.19)$$

must be positive definite. Optimum threshold settings T_1 and T_2 are the solution of (2.16) and (2.17) that corresponds to the global minima, so all possible solutions of (2.16) and (2.17) must be tried. The coupling between (2.16) and (2.17) to determine the thresholds represents the cooperation that can occur between the two local detectors to minimize the overall decision cost.

2. 'OR' Fusion

The decision of the OR fusion is given by

$$u_o = u_1 + u_2 - u_1 u_2. \quad (2.20)$$

The probability of detection P_d (OR) and probability of false alarm P_f (OR) are given by

$$P_d(\text{OR}) = 1 - \int_{-\infty}^{T_1} \int_{-\infty}^{T_2} f(y_1, y_2 / H_1) dy_1 dy_2 \quad (2.21)$$

and

$$P_f(\text{OR}) = 1 - \int_{-\infty}^{T_1} \int_{-\infty}^{T_2} f(y_1, y_2 / H_0) dy_1 dy_2 \quad (2.22)$$

while the necessary conditions for optimality are

$$\Lambda(T_1) = C \frac{\int_{-\infty}^{T_2} f(y_2 / T_1, H_0) dy_2}{\int_{-\infty}^{T_2} f(y_2 / T_1, H_1) dy_2} \quad (2.23)$$

and

$$\Lambda(T_2) = C \frac{\int_{-\infty}^{T_1} f(y_1 / T_2, H_0) dy_1}{\int_{-\infty}^{T_1} f(y_1 / T_2, H_1) dy_1}. \quad (2.24)$$

Again the Hessian matrix must be positive definite.

3. Solution of the Nonlinear Threshold Equations

The pair of coupled equations (2.16), (2.17) for the AND fusion and (2.23) and (2.24) for the OR fusion can be solved using Max's technique [18]. The technique

is summarized as follow: pick a value of T_1 and calculate T_2 from (2.16) or (2.23). If the calculated value of T_2 does not agree with that value calculated from (2.17) or (2.24) then T_1 must be chosen again. This approach is time consuming. Another approach is the method of successive substitution [19]. We first put the two equations in the form

$$T_{1_{k+1}} = G(T_{1_k}, T_{2_k}) , T_{2_{k+1}} = F(T_{1_{k+1}}, T_{2_k}) \quad (2.25)$$

then start with a reasonable guess for $(T_1)_0$ and $(T_2)_0$. A suitable initial guess is the locally optimum solutions, i.e. the thresholds that would optimize the detection if each sensor works alone. These will be denoted by T_{110} and T_{210} . For known signals in gaussian noise these are

$$(T_i)_0 = a_i / 2 + \log(C) / a_i . \quad (2.26)$$

4. Numerical Results

We have solved the threshold equations for both fusion rules for $a_1 = 1.7$ and $a_2 = 2.3$ for several values of ρ and C .

To compare AND and OR fusion, define K as the ratio of the AND cost to the OR cost.

$$K = \frac{1 + C P_f(\text{AND}) - P_d(\text{AND})}{1 + C P_f(\text{OR}) - P_d(\text{OR})} \quad (2.27)$$

We have also computed the Receiver Operating Characteristic⁴ (ROC) curves of classical communication theory [20] for each fusion rule.

Figure 2.2 shows the ratio K as a function of C for $\rho = 0, 0.2, 0.4$. The figure shows that AND fusion is optimum for $C \geq 1$ and OR fusion is optimum for lower values of C . The same is clear from Figure 2.3; ROC curves of AND fusion are above those of OR fusion for $C \geq 1$ and lower otherwise. The performance difference becomes smaller as the correlation coefficient increases. Also the figures show that the performance degrades for both fusion rules as ρ tends to one. This is in sharp contrast to CD which has perfect detection for $\rho = 1$.

⁴ P_d as a function of P_f

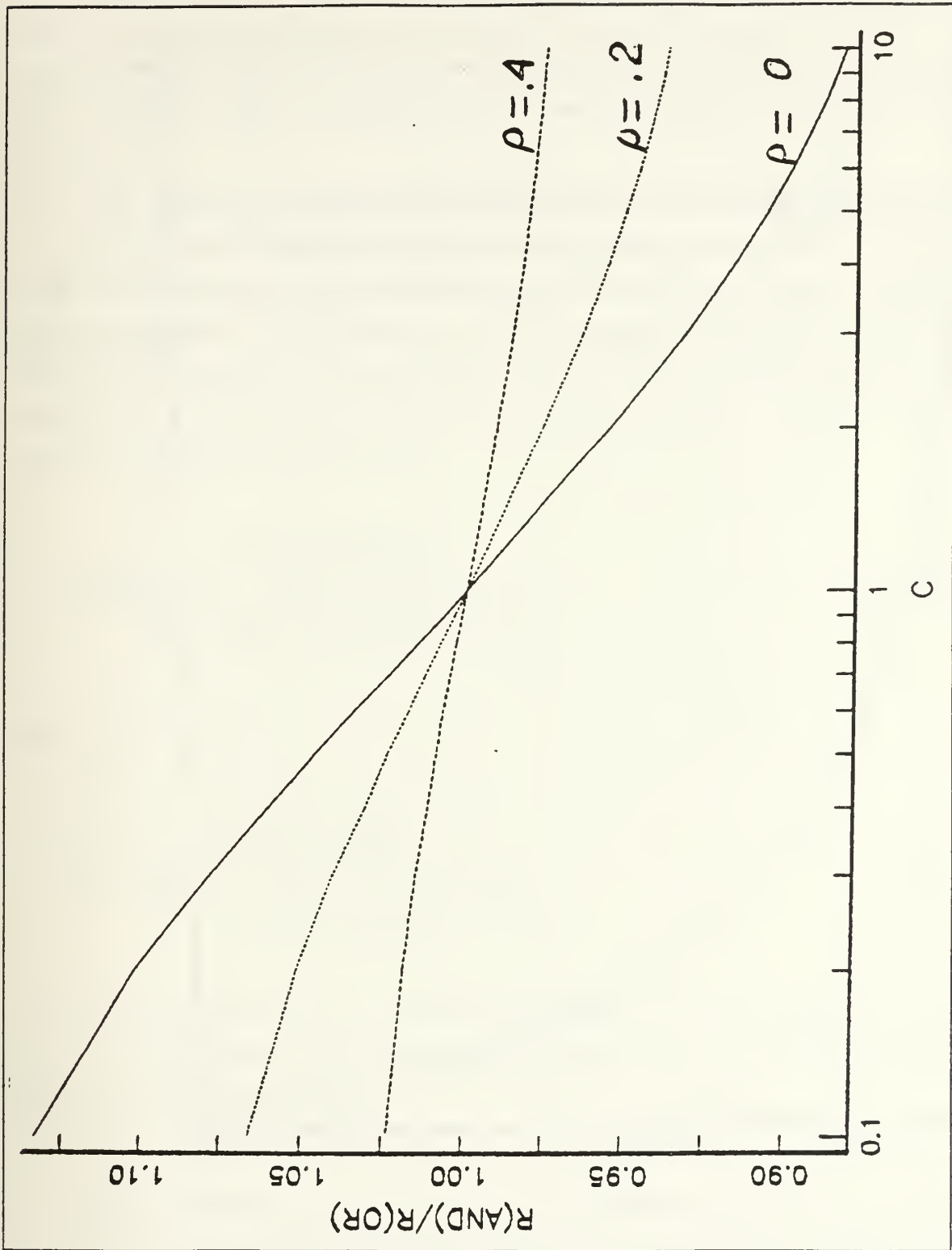

Figure 2.2 Ratio of Costs of AND and OR Fusion Rules
 $a_1 = 1.7, a_2 = 2.3.$

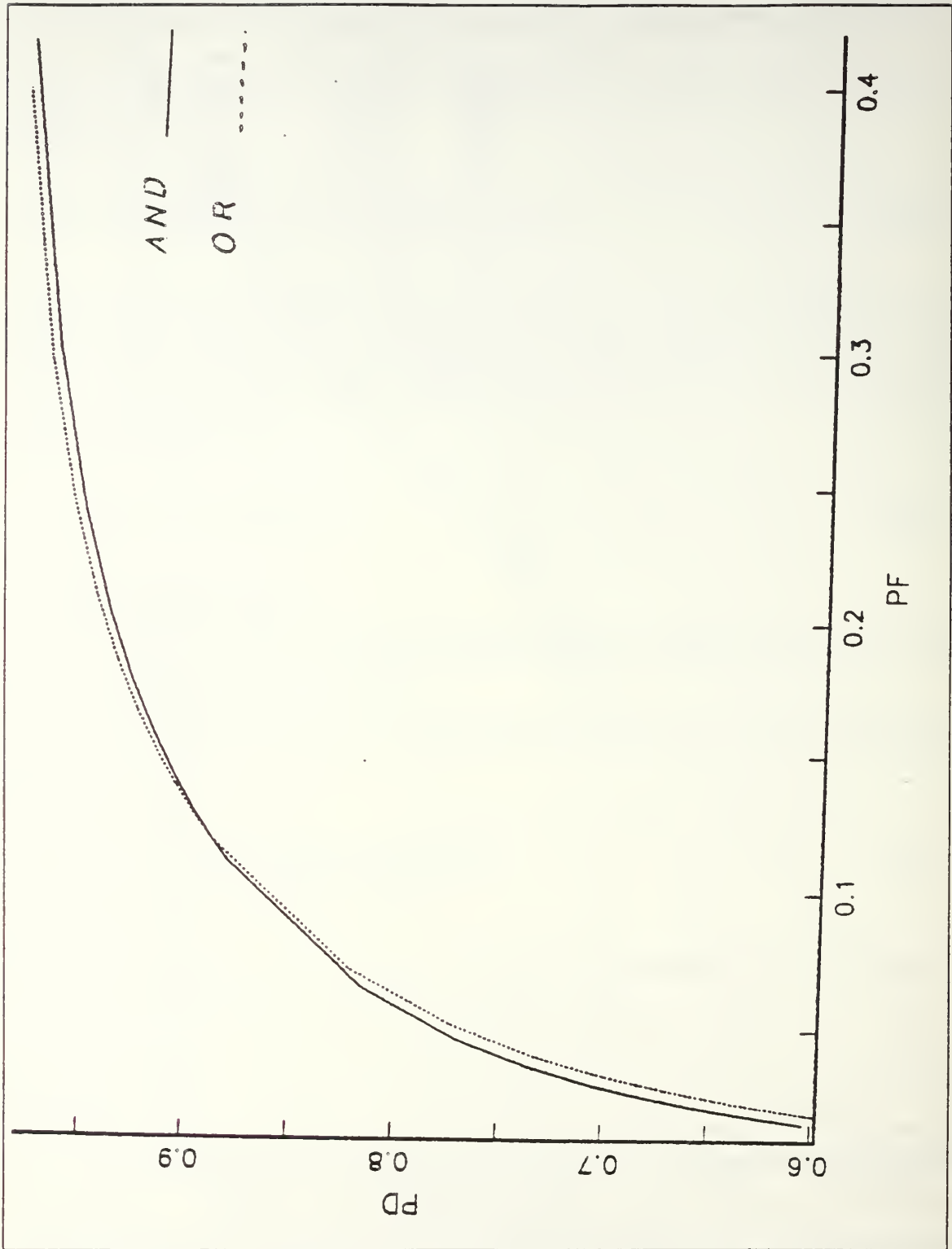

Figure 2.3 ROC Curves of AND and OR Fusion Rules
 $a_1 = 1.7, a_2 = 2.3.$

The same effects can be concluded from Figure 2.4 and Figure 2.5. Figure 2.4 shows the ratio K as a function of C for $a_1 = 1$ and $a_2 = 2$ and for $\rho = 0, 0.25, 0.5$. Figure 2.5 shows the ROC curves for both fusion rules for the same case. The figure shows that AND fusion is optimum for $C \geq 1$ and OR fusion is optimum for lower values of C .

C. THE EFFECT OF CORRELATION BETWEEN SENSOR OBSERVATIONS

So far we have answered the question of the optimum fusion rule. For $C \geq 1$ AND fusion is optimum. Let us now examine the effect of the correlation coefficient ρ on the performance of AND fusion for $C \geq 1$ (its range of superiority). We assume without loss of generality that a_2 is greater than a_1 . The two necessary conditions for optimality of AND fusion are (2.16) and (2.17). For the problem of known signal in gaussian noise these can be written as:

$$\Lambda_1(T_1) = C \frac{\operatorname{erfc} \left\{ \frac{T_2 - \rho T_1}{\sqrt{(1-\rho^2)}} \right\}}{\operatorname{erfc} \left\{ \frac{T_2 - a_2 - \rho(T_1 - a_1)}{\sqrt{(1-\rho^2)}} \right\}} \quad (2.28)$$

and

$$\Lambda_2(T_2) = C \frac{\operatorname{erfc} \left\{ \frac{T_1 - \rho T_2}{\sqrt{(1-\rho^2)}} \right\}}{\operatorname{erfc} \left\{ \frac{T_1 - a_1 - \rho(T_2 - a_2)}{\sqrt{(1-\rho^2)}} \right\}} \quad (2.29)$$

Notice that C appears only as a multiplicative constant in the two equations. The role of ρ is not that obvious. Examining the two equations leads to the following insights about the role of ρ :

1. $T_1 = -\infty$ and $T_2 = T_{210}$ is a solution. This corresponds to the decision rule of D_2 .
2. $T_2 = -\infty$ and $T_1 = T_{110}$ is a solution. This corresponds to the decision rule of D_1 .
3. If a_2 is greater than a_1 we expect the performance of D_2 alone to be better than that of D_1 alone and that of the selfish decision rule in which each detector tries to minimize its own detection cost, not the system decision cost, by using T_{110} , T_{210} .

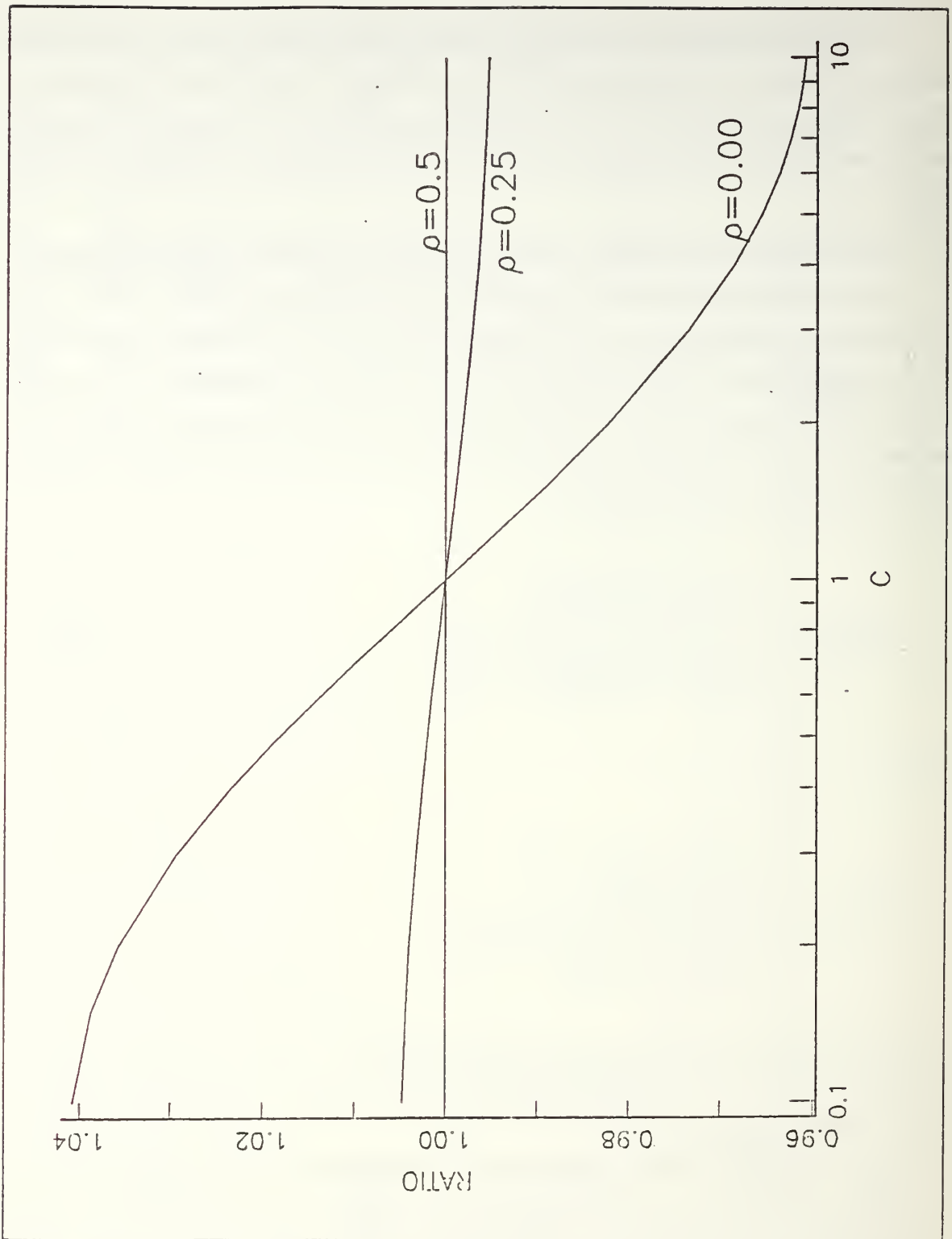

Figure 2.4 Ratio of Costs of AND and OR Fusion Rules
 $a_1 = 1, a_2 = 2.$

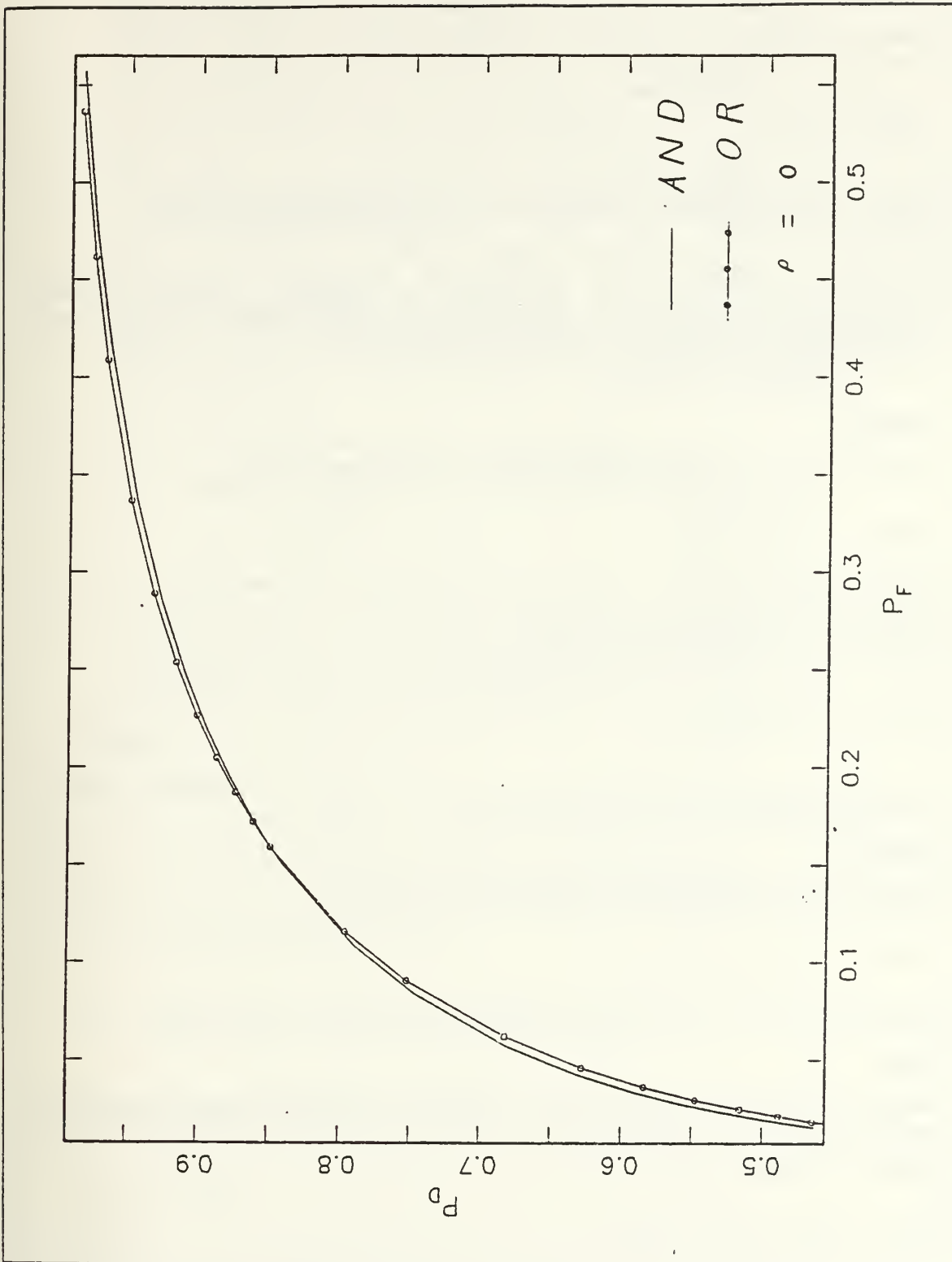

Figure 2.5 ROC for AND and OR Fusion Rules
 $a_1 = 1, a_2 = 2.$

We now prove three lemmas concerning these equations.

1. **Lemma 1.**

For $\rho \leq a_1/a_2$,

$$T_1 \leq T_{110}$$

and

$$T_2 \leq T_{210}$$

where T_{i10} is the optimum threshold of the i th detector operating alone.

Proof:

Since the argument of the complement of the error function in each denominator is less than the argument in the corresponding numerator, the fraction is always less than one. This implies that

$$\Lambda_i(T_i) \leq C, i=1,2.$$

2. **Lemma 2**

For $\rho = a_1/a_2$, the only possible solution of (2.28) and (2.29) is:

$$T_2 = T_{210}$$

and

$$T_1 = -\infty.$$

Proof:

For $\rho = a_1/a_2$ equation (2.29) becomes

$$\Lambda_2(T_2) = C = \Lambda_2(T_{210}). \quad (2.30)$$

The corresponding value of T_1 is $T_1 = -\infty$.

3. **Lemma 3**

For $\rho \geq a_1/a_2$ the optimum solution for T_1 and T_2 is:

$$T_1 = -\infty$$

and

$$T_2 = T_{210}.$$

This means that the decision of the optimum AND fusion is that of D_2 .

Proof:

Recall that the CD threshold line divides the observation space into two decision regions. For positive signals the following inequality is satisfied in the region to the right of the CD line:

$$C f(y_1, y_2 / H_0) < f(y_1, y_2 / H_1). \quad (2.31)$$

The converse of this inequality is true in the left region. The decision region Z_1 of any other decision rule contains areas from the right and from the left of the CD line. Areas to the right will have a negative contribution to the decision cost while areas to the left will have positive contributions. Now assume that T_1 and T_2 , where both are finite, satisfy the necessary condition (2.28) and (2.29). We shall prove that they cannot correspond to the optimum solution. The finite point (T_1, T_2) either lies to the left or to the right of the CD threshold line as shown in Figure 2.6 a and b respectively. In Figure 2.6 a the intersection of the CD line with the line $y_1 = T_1$ is a better solution since it excludes an area in which $C f(y_1, y_2 / H_0)$ is greater than $f(y_1, y_2 / H_1)$. A better solution than this has the same T_2 but with $T_1 = -\infty$ since the added area has negative contribution to the cost. In Figure 2.6 b, $T_1 = -\infty$ and T'_2 is a better solution than T_1 and T_2 , since the added area has a negative contribution to the cost. In both cases $T_1 = -\infty$ is the optimum solution and the corresponding optimum value of T_2 is T_{2lo} .

As a result of the above three lemmas it is clear that

1. Any solution of the necessary conditions must satisfy

$$\begin{aligned} T_1 &\leq T_{1lo} \text{ and} \\ T_2 &\leq T_{2lo} \end{aligned}$$

2. The performance of the AND fusion saturates to that of D_2 alone for $\rho \geq a_1/a_2$. We might recall that the threshold line of the CD system changes slope at that value of ρ . We will refer to this value of ρ by ρ_{cr} . This result is in contradiction with Lauer and Sandell's results [4] which shows performance continuing to degrade with increasing ρ for

$$\rho \geq \rho_{cr}.$$

Limiting behavior for $\rho = -1$.

For $\rho = -1$ the joint probability density function $f(y_1, y_2 / H_0)$ has values only on the line $y_1 = -y_2$. So any threshold values T_1 and T_2 such that $T_1 = -T_2$ will produce AND fusion with zero probability of false alarm. This can be visualized from Figure 2.7. Consequently, P_d will be given by

$$P_d = 0.5 \operatorname{erfc} \left\{ \frac{T_2 - a_2}{a_2} \right\} - 0.5 \operatorname{erfc} \left\{ \frac{T_2 + a_1}{a_1} \right\}. \quad (2.32)$$

Maximizing P_d with respect to T_2 yields

$$T_2 = (a_2 - a_1)/2. \quad (2.33)$$

For the special case of equal SNR sensors, $T_2 = 0$.

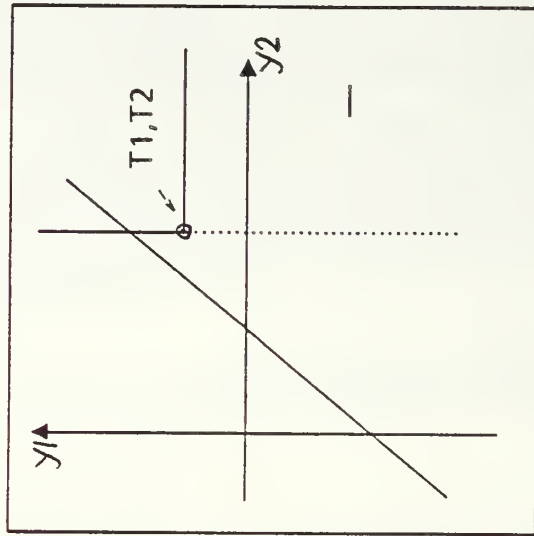

b) (T_1, T_2) to the right of the threshold line

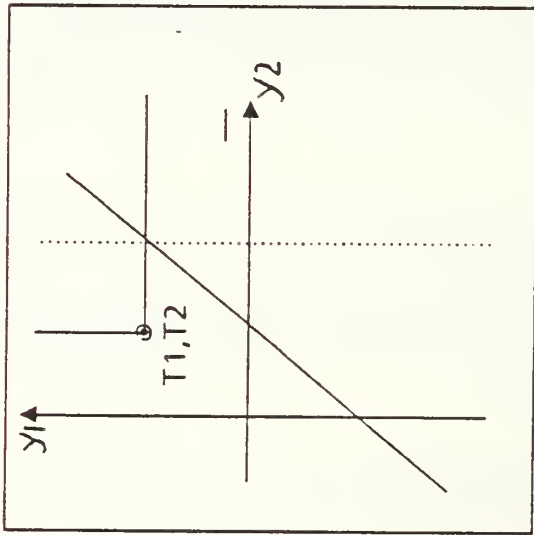

a) (T_1, T_2) to the left of threshold line

Figure 2.6 Optimum T_1 and T_2 for $\rho \geq a_1/a_2$.

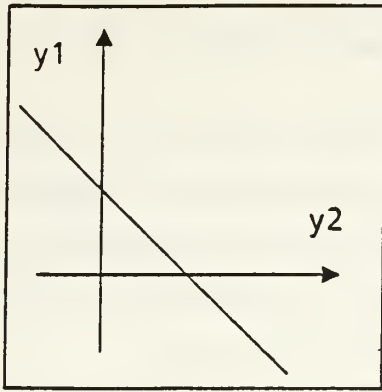

a) $\rho = a_1/a_2$

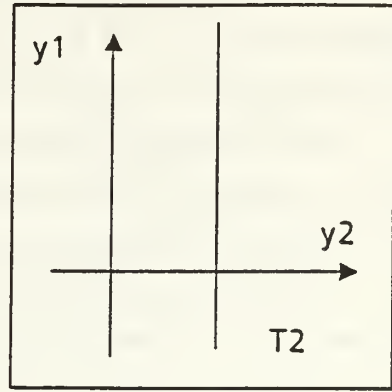

b) $\rho = a_1/a_2$

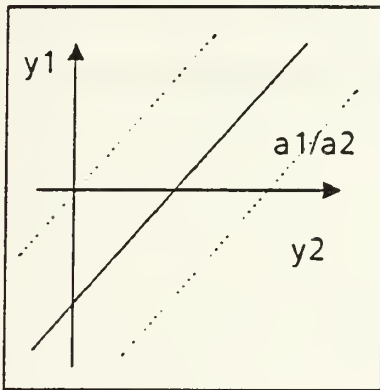

d) $\rho = 1$

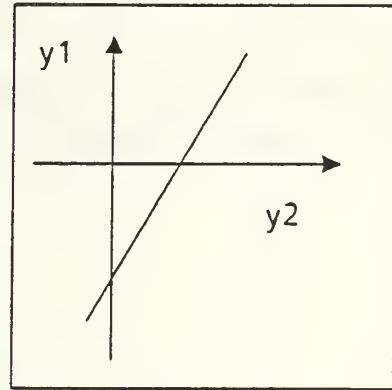

c) $\rho = a_1/a_2$

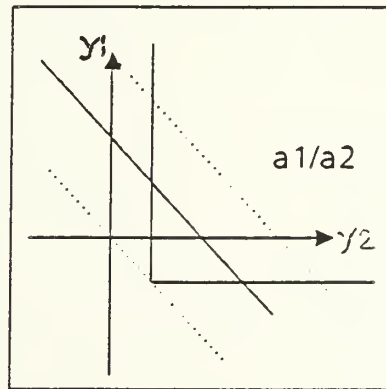

e) $\rho = -1$

Figure 2.7 Centralized Threshold Line For Different Values of ρ .

D. NUMERICAL RESULTS

The average decision costs vs ρ for $a_1 = a_2 = 2$, and $C = 1$ are shown in Figure 2.8. Threshold values T_1 and T_2 vs ρ for the same case are shown in Figure 2.9. Figures 2.10 and 2.11 show the same for $C = 10$.

These four figures for the case of equal signal-to-noise ratio show that the two detectors cooperate with each other using the same decision rule (equal thresholds). Their threshold is an increasing function of ρ . The limit of this threshold as $\rho \rightarrow -1$ is zero. This behavior agrees with (2.33). The limit of the threshold as $\rho \rightarrow 1$ is T_{10} . This is because for $\rho \rightarrow 1$ the two systems have identical observations.

The detection cost curves show that the cost is an increasing function of ρ . The curve of the AND fusion has the same shape as the curve of the CD system. Both systems attain their best performance at $\rho = -1$. They have the same worst performance for $\rho = 1$.

Figures 2.12 and 2.13 represent the case of unequal SNR sensors for $C = 1$. Figures 2.14 and 2.15 show the same for $C = 10$.

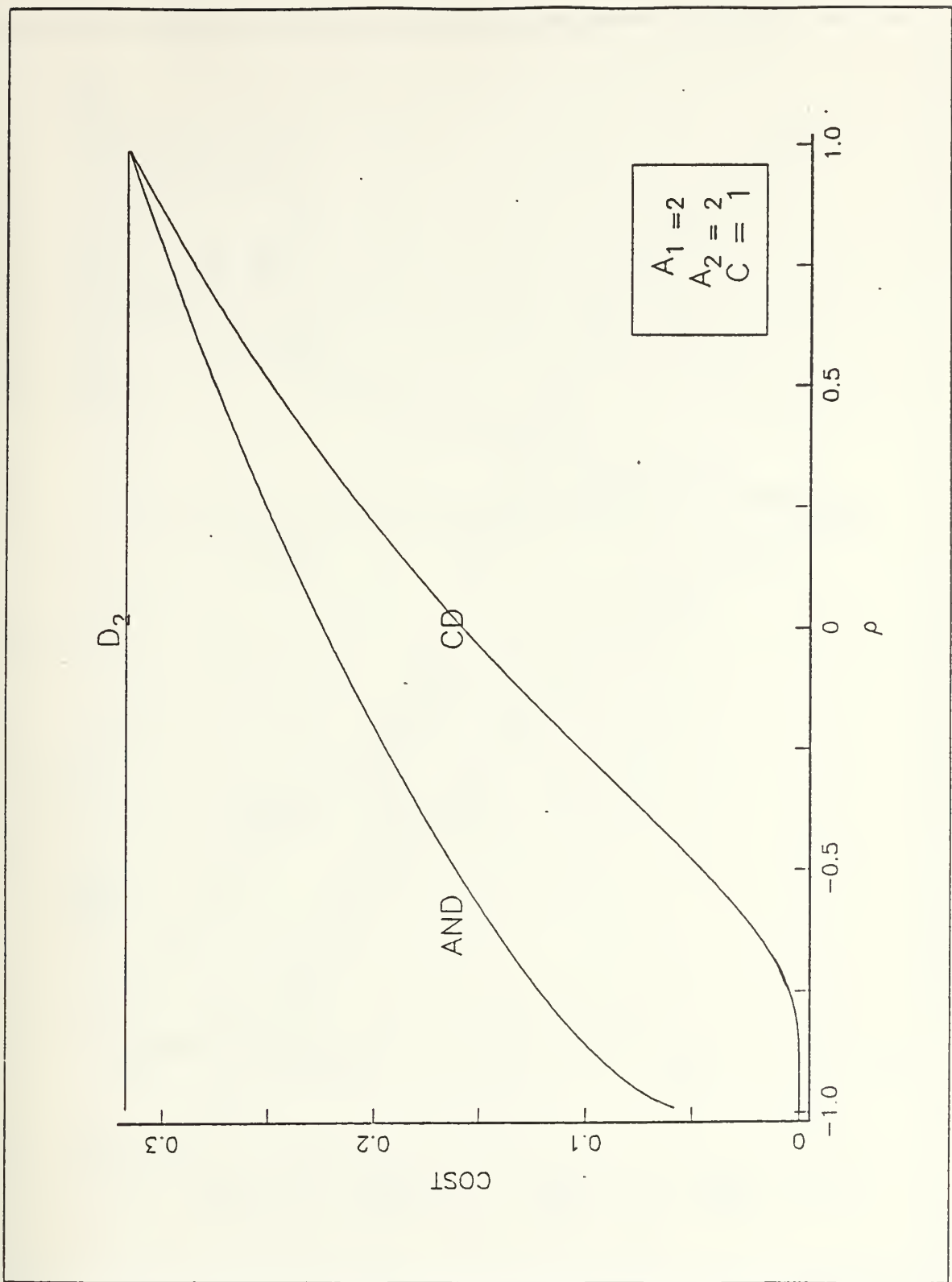

Figure 2.8 Average Decision Costs for Equal SNRs, $C = 1$.

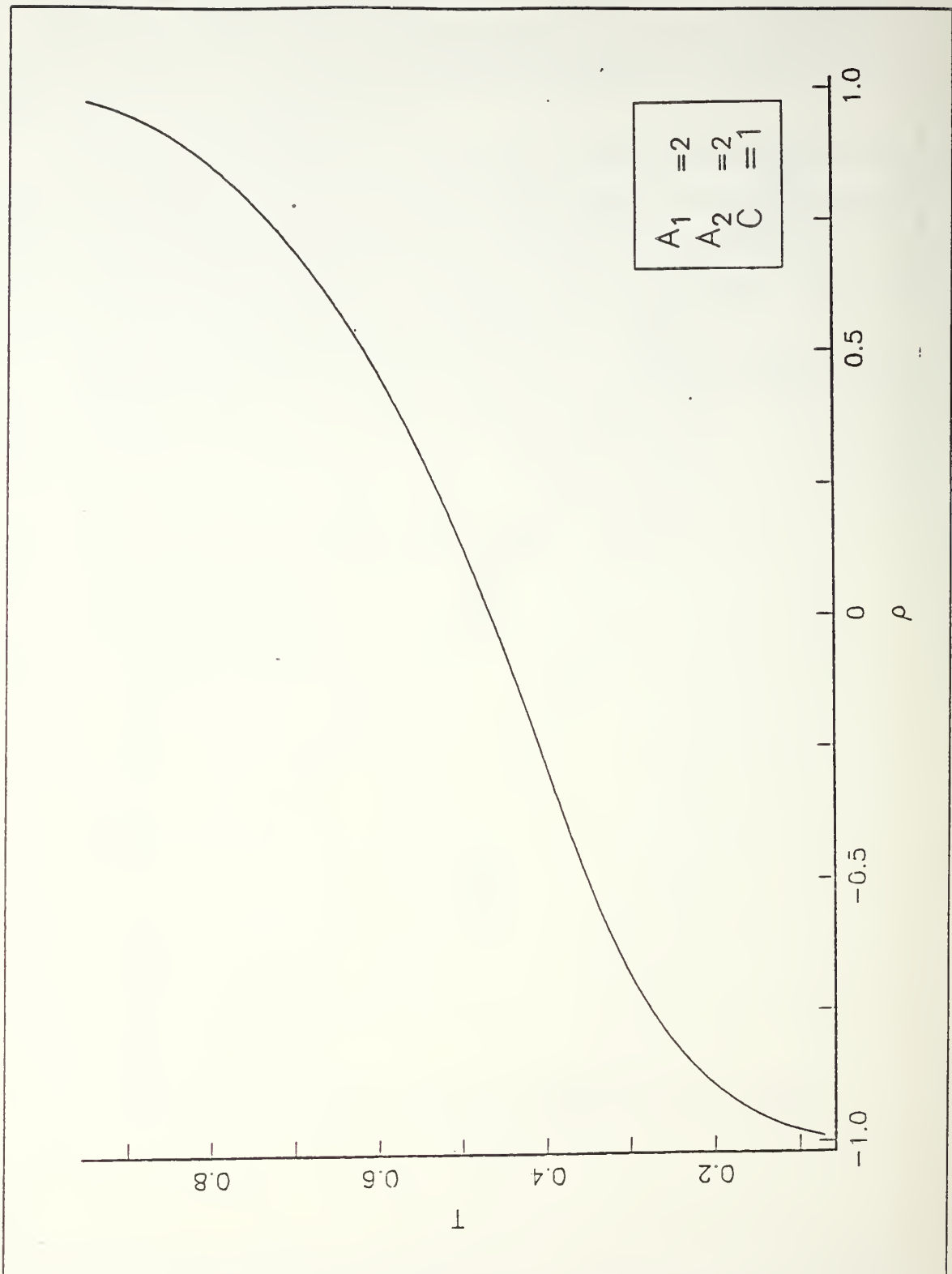

Figure 2.9 Threshold Value for Equal SNRs, $C = 1$.

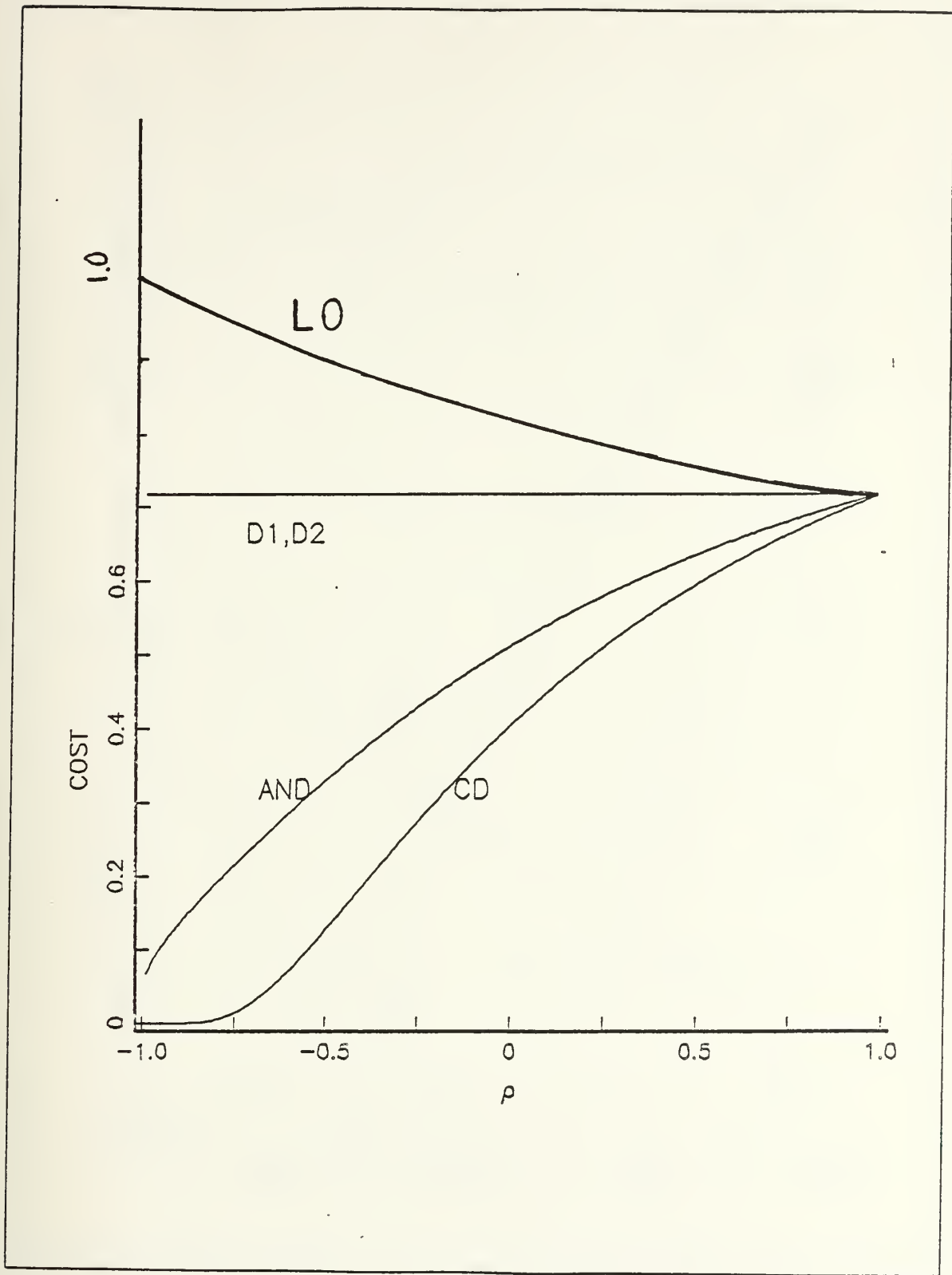

Figure 2.10 Average Decision Costs for Equal SNRs, $C=10$.

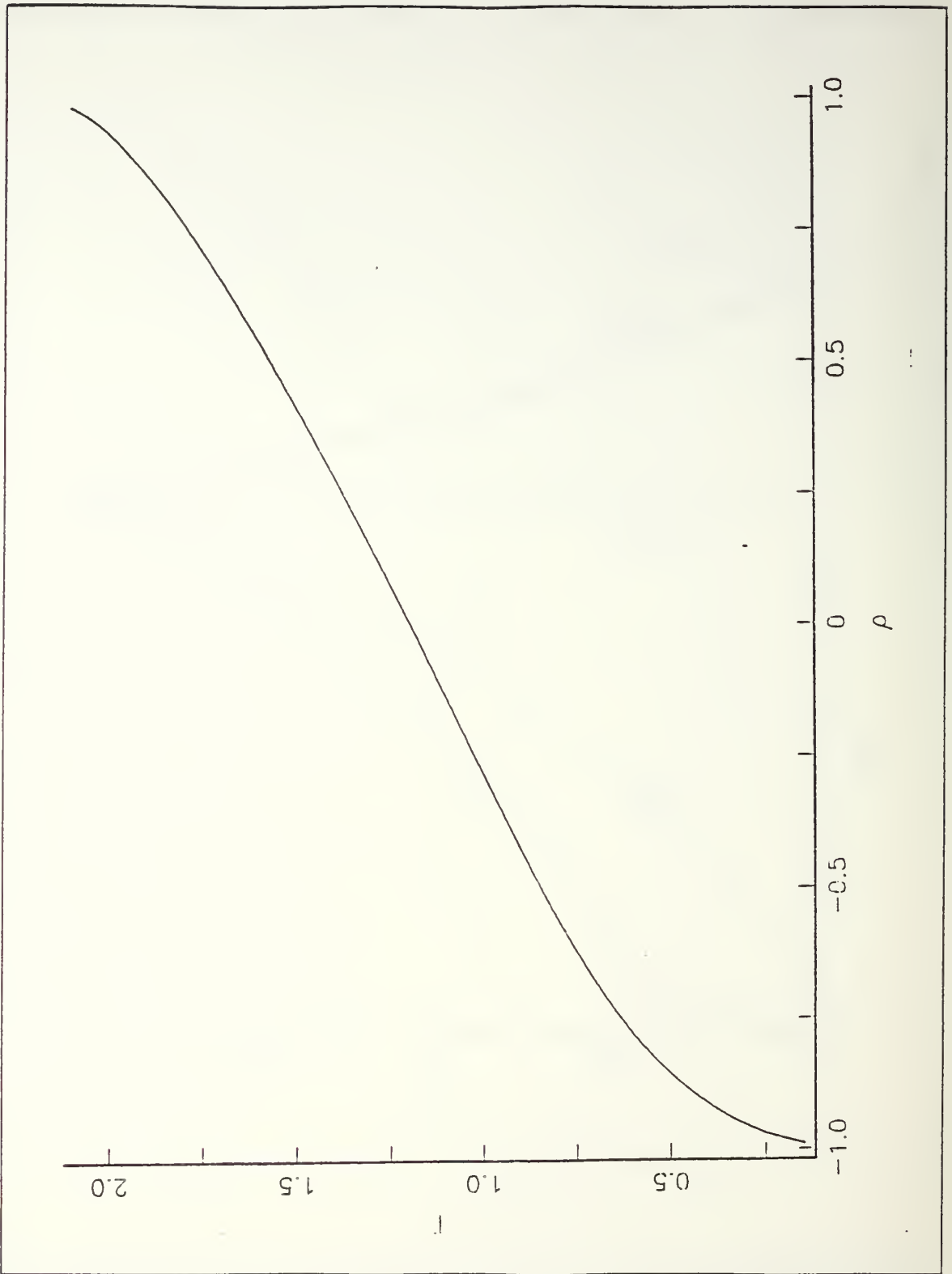

Figure 2.11 Threshold Value for Equal SNRs, $C = 10$.

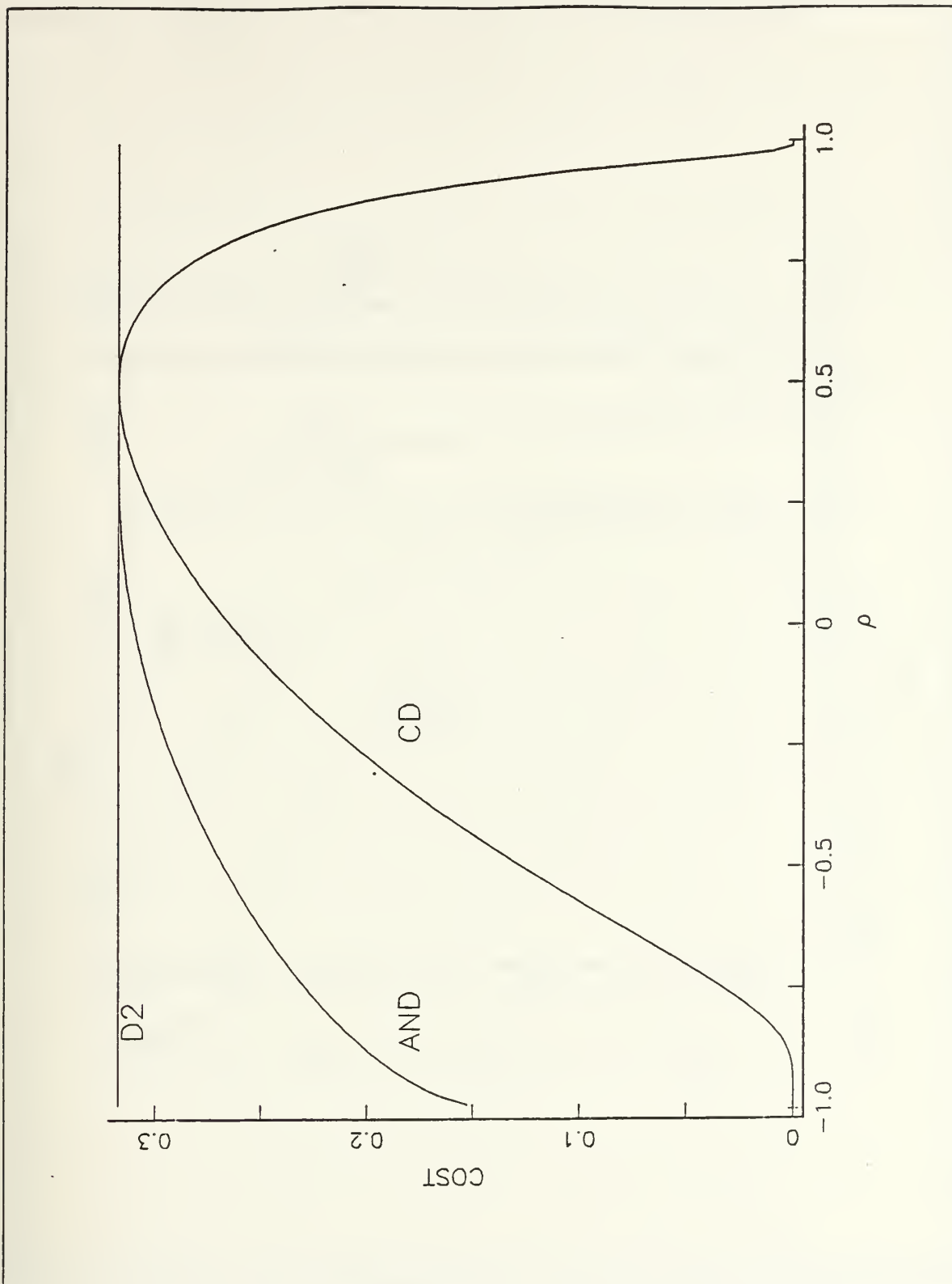

Figure 2.12 Average Decision Costs for Unequal SNRs, $C = 1$.

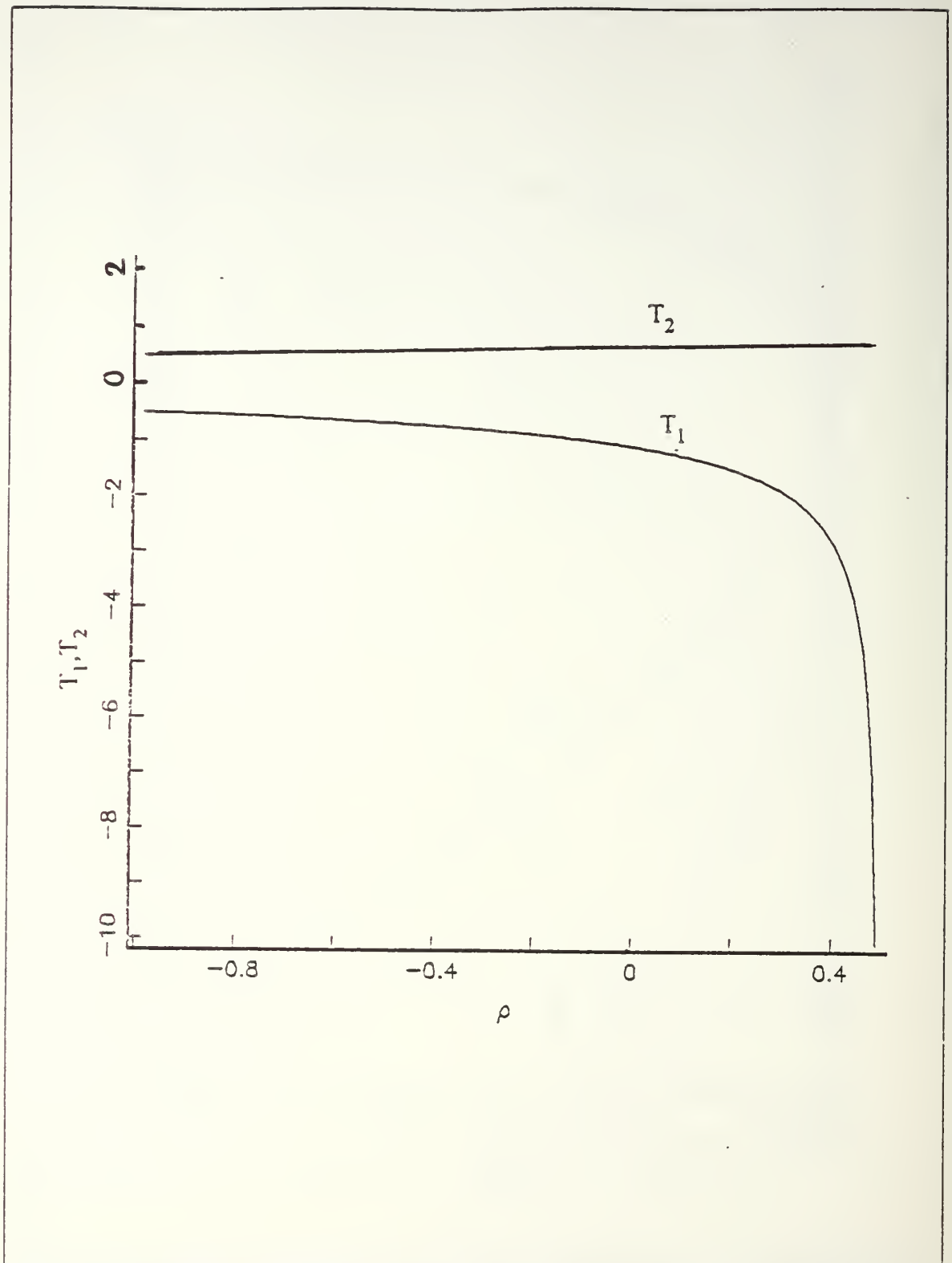

Figure 2.13 Threshold Value for Unequal SNRs, $C=1$.

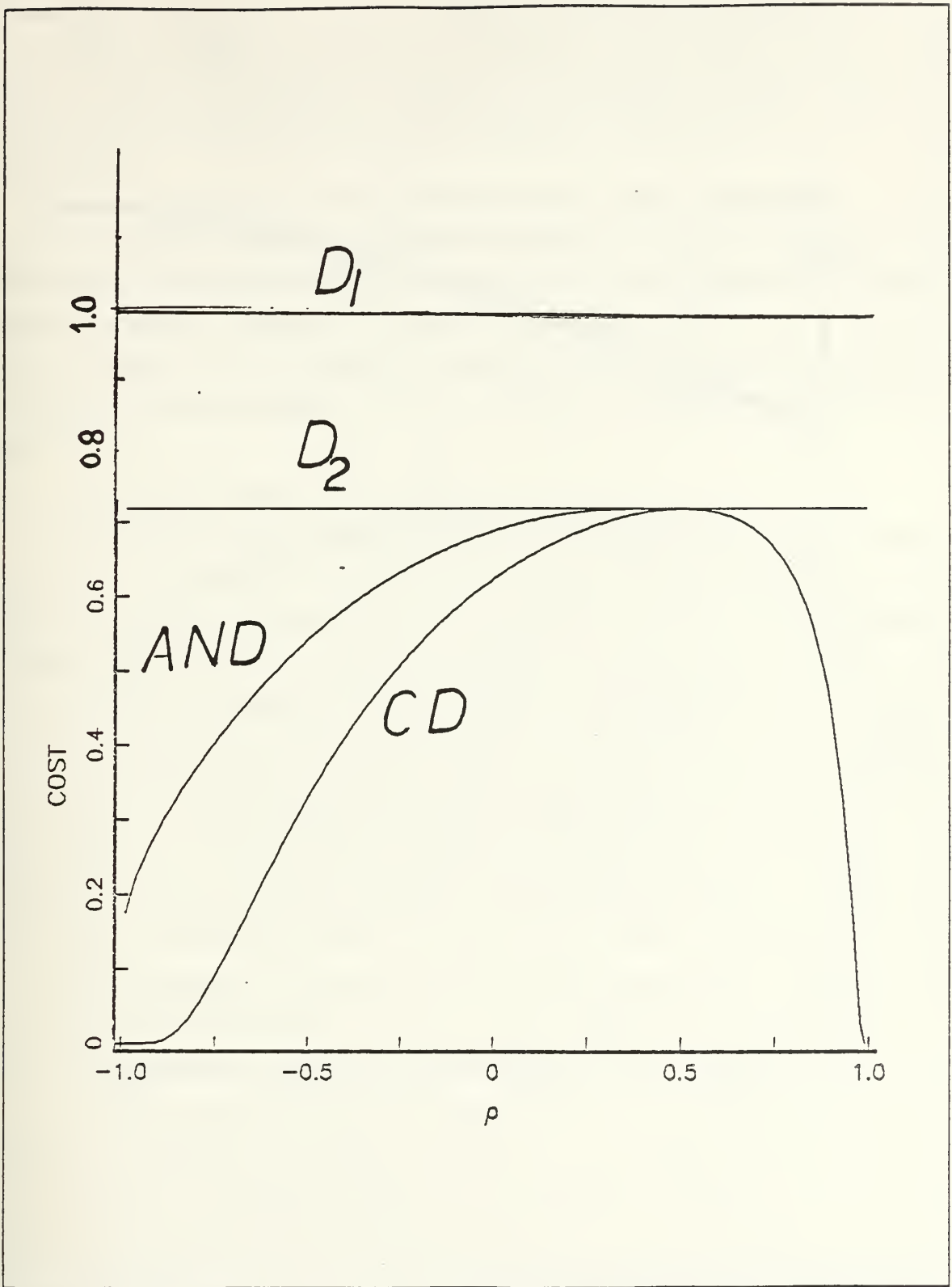

Figure 2.14 Average Decision Costs for Unequal SNRs, $C = 10$.

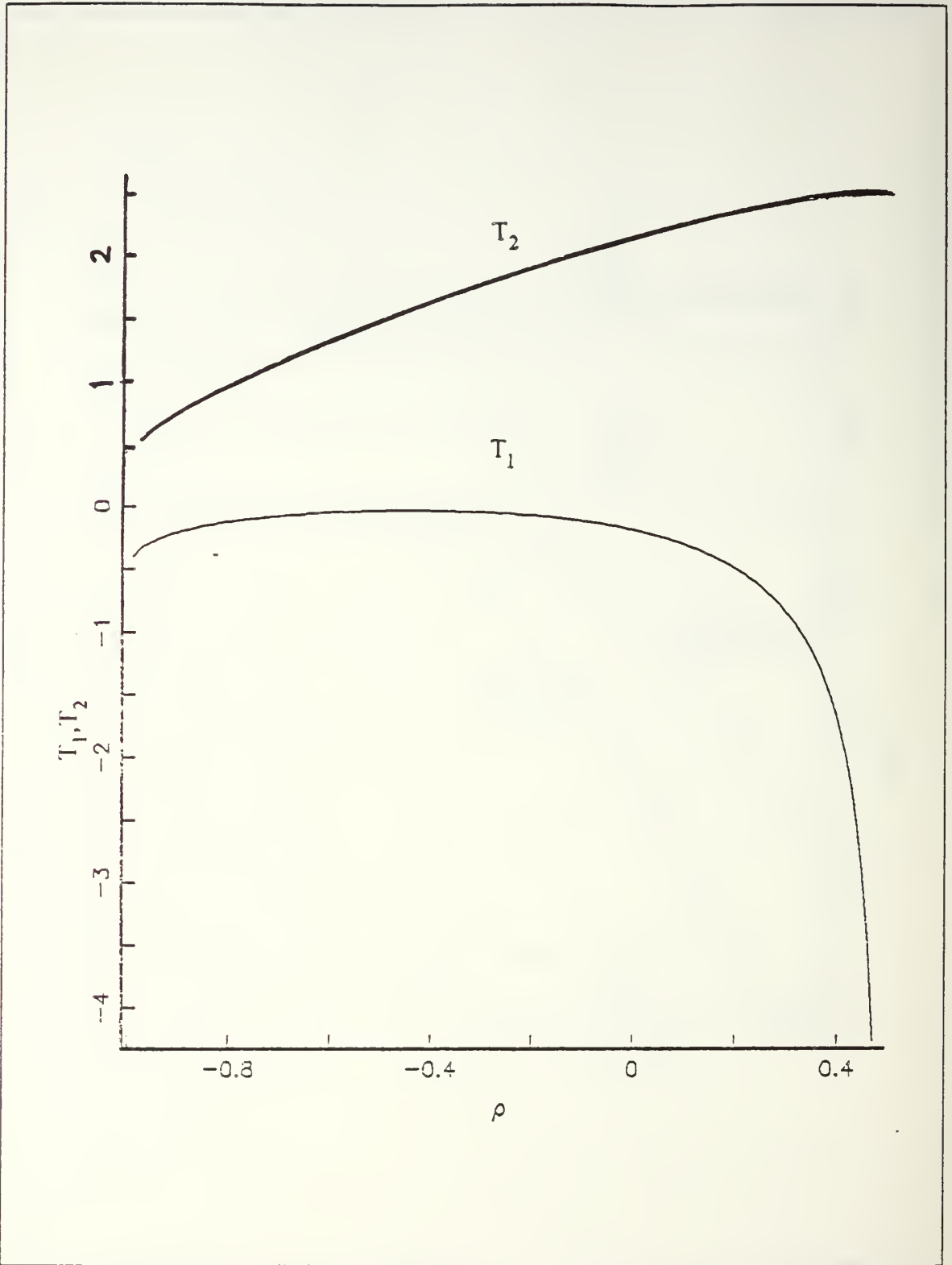

Figure 2.15 Threshold Value for Unequal SNRs, $C = 10$.

These four figures for the case of unbalanced sensors show that, the two detectors cooperate using different thresholds. The threshold of the higher signal-to-noise detector is an increasing function of ρ while the other threshold is a decreasing function of ρ .

The cost curves show that the fusion rule has its best performance at $\rho = -1$. Both DD and CD have their worst performance at $\rho = \rho_{cr}$. For $\rho \geq \rho_{cr}$ the performance of the optimum fusion rule is the same as the detector of the higher signal-to-noise ratio. Recall that CD system has perfect detection for $\rho = 1$ when the SNR's are unequal. As C increases the average cost of each system increases. This can be explained from the expression for R in which the probability of false alarm is weighted by C.

E. DISCUSSION AND CONCLUSIONS

We have shown that the optimum fusion rule is determined by the ratio of costs and the apriori probabilities. For equal error costs AND and OR fusion rules are equivalent. This is not surprising since each system turns out to be the minimum probability of error detector; thresholds are adjusted such that $1 - P_d = P_f$. It might also be noted that the optimality of the fusion rule is independent of the correlation coefficient and the signal-to-noise ratio in this case. We also note that the detection cost of the optimum fusion rule has its minimum value at $\rho = -1$. It has its maximum value at $\rho = a_1/a_2$. The performance saturates at the cost of decision of the detector of higher SNR. In the interval ($\rho \in [a_1/a_2, 1]$), the optimum fusion rule ignores the decision of the detector of lower SNR. As a good dynamical example that agrees with this result is the switched diversity combiner [21] in fading environments and its centralized counterpart, the maximum ratio diversity combiner [22]. Recall that for unequal SNRs the performance of the CD system improves in this interval and has perfect detection for $\rho = 1$. Also it is important to note that the optimum thresholds of the individual observers are not the same as if they were operating independently, but must be determined by simultaneous solution of two coupled nonlinear equations. This represents the cooperation between the two detectors to work as a team. Lastly the performance difference between CD and DD is due to the information loss in local data processing. However DD has fewer requirements on the communication channel in contrast to CD which requires infinite bandwidth. A compromise between these two extremes is to allow more information than just decisions to be sent to the fusion

center. This is the concept behind the Quantized Detection algorithm considered in the following two chapters.

III. DETECTION USING QUANTIZED SENSOR OBSERVATIONS

A. INTRODUCTION

So far detection with sensor observations has been described using two methods. In the first method all sensor observations are sent to some central processor which makes a decision based on a likelihood ratio test. In the second method only local decisions are sent to the central processor which fuses these decisions into a global decision. While the first method is very easy to design it requires in principle infinite bandwidth communication channels. The second method requires only one information bit per detection. Detection with quantized sensor observations will be introduced in this chapter. The main goal of the chapter is to grade the road from the DD problem to the CD problem. It will be referred to by Quantized Detection, QD. The performance improvement of the DD problem will be traced as the amount of information delivered to the fusion center increases.

First let us consider the problem of the Primary Decision Maker (PDM) and its quantized second opinion (consultant). We will prove three theorems concerning the decision rule of the PDM. Then fusion of two quantized observations of an arbitrary number of levels will be considered. As a special case, fusion of two sensor observations, one quantized to N levels and the other to $N+1$ levels, will be proven equivalent to the PDM and an N -level quantizer. Comparison between different configurations will follow.

B. TEAM DECISION OF A PRIMARY DECISION MAKER AND A SECOND OPINION QUANTIZER.

1. Formulation of the PDM Problem

Consider the structure of Figure 3.1 in which y_1 is quantized into y_{1q} by the quantization rule α of N levels.

$$\alpha : Y_1 \rightarrow Y_{1q} . \quad (3.1)$$

The primary decision maker will make his decision u_o , about the phenomena H based on its own observation y_2 and the quantized observation y_{1q} .

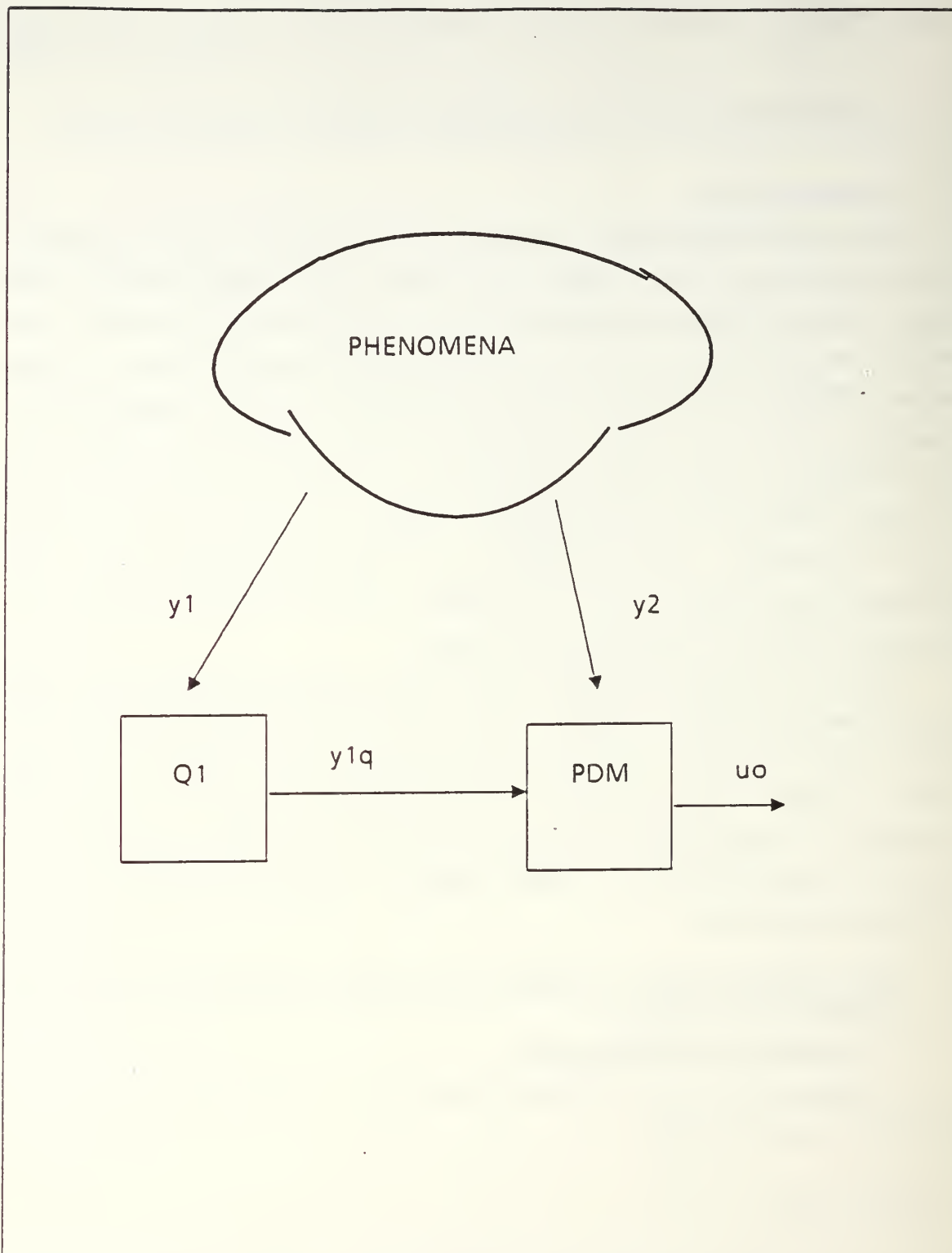

Figure 3.1 Configuration A, The Primary Decision Maker and its Quantized Consultant.

The problem of the PDM is

1. to design the quantization rule α i.e. to specify the set of N points

$$-\infty = X_1 \leq X_2 \leq \dots \leq X_N < \infty$$
 that defines the quantizer intervals, and
2. to design the decision rule γ_2

$$\gamma_2 : Y_{1q} \times Y_2 \rightarrow (0, 1) \quad (3.2)$$

in order to minimize the decision cost.

2. Problem Analysis

Our approach is as follows. We first design the optimum Bayes decision rule given a set of quantizer parameters. Next, the average cost is expressed as a function of these parameters. We then minimize the average cost with respect to them.

a. The Optimum PDM Given Some Quantization Rule α

We have shown in Chapter I that, to within an additive and a multiplicative positive constant the average cost is given by [6]

$$R = C P_f - P_d \quad (3.3)$$

where C is the ratio of error costs and P_f and P_d are the probability of false alarm and probability of detection respectively. The PDM receives a quantized level $y_{1q} = Q_j$. He will make his decision on the basis of his own observation y_2 and y_{1q} . The performance of the the primary decision maker, given some quantization rule α , is given by the following lemma.

Lemma 3.1

The probability of detection and probability of false alarm of the Primary Decision Maker are given by:

$$P_d = \sum_{i=1}^N \int_{X_j}^{X_{j+1}} \int_{y_2 \in Z_{1j}} f(y_1, y_2 / H_1) dy_1 dy_2 \quad (3.4)$$

and

$$P_f = \sum_{i=1}^N \int_{X_i}^{X_{i+1}} \int_{y_2 \in Z_{1j}} f(y_1, y_2 / H_0) dy_1 dy_2 \quad (3.5)$$

where Z_{1j} is the decision region Z_1 given that $y_1 \in [X_j, X_{j+1}]$.

Proof:

The proof is given in Appendix (A).

The decision rule of the Primary Decision Maker is given by Theorem 3.1.

Theorem 3.1

Given y_{1q} and y_2 the decision rule of the Primary Decision Maker of Figure 3.1 is

1. deterministic

$$\gamma_2 : Y_{1q} \times Y_2 \rightarrow (0, 1) \quad (3.6)$$

2. a likelihood ratio test

$$u_o = \begin{cases} 1 & \text{if } \Lambda(y_2) \geq \Theta_j(y_2) \\ 0 & \text{if } \Lambda(y_2) < \Theta_j(y_2) \end{cases} \quad , j = 1, 2, \dots, N \quad (3.7)$$

where $\Lambda(y_2) = f(y_2 / H_1) / f(y_2 / H_0)$

3. the threshold function $\Theta_j(y_2)$ is given by

$$\Theta_j(y_2) = \frac{\int_{X_j}^{X_{j+1}} f(y_1 / y_2, H_0) dy_1}{\int_{X_j}^{X_{j+1}} f(y_1 / y_2, H_1) dy_1} \quad , j = 1, 2, \dots, N. \quad (3.8)$$

Proof

We first insert (3.4) and (3.5) into (3.3). Each term of the detection cost (3.3) is then given by

$$R_j = \int_{y_2 \in Z_{1j}} \int_{X_j}^{X_{j+1}} [C f(y_1, y_2 / H_0) - f(y_1, y_2 / H_1)] dy_1 dy_2 \quad (3.9)$$

To make R_j in (3.9) negative an optimum decision rule assigns y_2 to Z_1 if

$$C \int_{X_j}^{X_{j+1}} f(y_1, y_2 / H_0) dy_1 - \int_{X_j}^{X_{j+1}} f(y_1, y_2 / H_1) dy_1 \geq 0 \quad , j=1,2,\dots,N \quad (3.10)$$

otherwise it will assign y_2 to Z_0 .

Applying Bayes rule and rearranging terms, decision rule (3.10) can be written as

$$\Lambda(y_2) \geq C \frac{\int_{X_j}^{X_{j+1}} f(y_1/y_2, H_0) dy_1}{\int_{X_j}^{X_{j+1}} f(y_1/y_2, H_1) dy_1} \quad , j=1,2,\dots,N \quad (3.11)$$

which completes the proof.

b. Optimum Quantization of \bar{Y}_1

According to Theorem 3.1, the decision rule of the PDM is a likelihood ratio test with data dependent threshold. The threshold depends on the choice of X_j 's. To find an optimum solution for the X_j 's is not any easier than that of the DD problem. Recall that for the DD problem optimum solutions are possible only for the case of conditionally independent observations. Only suboptimal solutions are possible for the case of correlated observations. We will not expect more for the QD problem. Let us consider each case separately.

3. Conditionally Independent Observations

Under the assumption of conditionally independent observations, i.e.

$$f(y_1/y_2, H) = f(y_1/H) \quad (3.12)$$

the decision rule of the Primary Decision Maker can be simplified. This decision rule is given by the following corollary of Theorem 3.1.

Corollary 1

Assuming conditionally independent sensor observations, and given y_{1q} and y_2 , the decision rule of the Primary Decision Maker of Figure 3.1 is

1. deterministic

$$\gamma_2 : Y_{1q} \times Y_2 \rightarrow (0, 1) \quad (3.13)$$

2. a likelihood ratio test

$$u_o = \begin{cases} 1 & \text{if } \Lambda(y_2) \geq \Theta_j \\ 0 & \text{if } \Lambda(y_2) < \Theta_j \end{cases}, j=1,2,\dots,N \quad (3.14)$$

where $\Lambda(y_2) = f(y_2/H_1)/f(y_2/H_0)$

3. the threshold Θ_j is given by

$$\Theta_j = C \frac{\int_{X_j}^{X_{j+1}} f(y_1/H_0) dy_1}{\int_{X_j}^{X_{j+1}} f(y_1/H_1) dy_1}, j=1,2,\dots,N. \quad (3.15)$$

Proof

By applying condition (3.12) in the threshold equation (3.8) one obtains (3.15) which completes the proof.

Let us denote the conditional probability of detection and the conditional probability of false alarm of the PDM given that the j_{th} quantization level of y_1 is received by P_{dj} and P_{fj} . Let Ψ_j be the set of all points y_2 for which

$$\Lambda_2(y_2) \geq \Theta_j \quad (3.16)$$

Then P_{dj} and P_{fj} can be written as

$$P_{dj} = \int_{\Psi_j} f(y_2/H_1) dy_2 \quad (3.17)$$

and

$$P_{fj} = \int_{\Psi_j} f(y_2/H_0) dy_2 \quad (3.18)$$

Equations (3.4) and (3.5) are now given by

$$P_d = \sum_{i=1}^N \int_{X_i}^{X_{i+1}} f(y_1/H_1) dy_1 \int_{\Psi_j} f(y_2/H_1) dy_2 \quad (3.19)$$

and

$$P_f = \sum_{i=1}^N \int_{X_i}^{X_{i+1}} f(y_1/H_0) dy_1 \int_{\Psi_j} f(y_2/H_0) dy_2 \quad (3.20)$$

Substituting (3.19) and (3.20) in (3.3), then differentiating R with respect to X_j , $\{j=2,3,\dots,N\}$ will yield necessary conditions for optimality of the set of N equations.

$$C \left[\int_{\Psi_k} f(X_k, y_2/H_0) dy_2 - \int_{\Psi_{k-1}} f(X_k, y_2/H_0) dy_2 \right] - \left[\int_{\Psi_k} f(X_k, y_2/H_1) dy_2 - \int_{\Psi_{k-1}} f(X_k, y_2/H_1) dy_2 \right] = 0, k=2,3,\dots,N. \quad (3.21)$$

Applying Bayes rule and rearranging terms, (3.21) can be written in the following way.

$$\Lambda(X_k) = C \frac{\int_{\Psi_k} f(y_2/H_0) dy_2 - \int_{\Psi_{k-1}} f(y_2/H_0) dy_2}{\int_{\Psi_k} f(y_2/H_1) dy_2 - \int_{\Psi_{k-1}} f(y_2/H_1) dy_2}, k=2,3,\dots,N \quad (3.22)$$

The set of N-1 necessary conditions (3.22) are general for any statistics of y_1 . For the special case when $\Lambda(y_2)$ is monotonic in y_2 , let T_j be the value of y_2 for which

$$\Theta_j = \Lambda_2(T_j), j=1,2,\dots,N. \quad (3.23)$$

So T_j is given by

$$\Lambda(T_j) = C \frac{\int_{X_j}^{X_{j+1}} f(y_1/H_0) dy_1}{\int_{X_j}^{X_{j+1}} f(y_1/H_1) dy_1}, j=1,2,\dots,N \quad (3.24)$$

For this case of monotonic $\Lambda(y_2)$ the set of necessary conditions for optimality (3.22) can be written as

$$\Lambda(X_k) = C \frac{\int_{T_k}^{\infty} f(y_2/H_0) dy_2 - \int_{T_{k-1}}^{\infty} f(y_2/H_0) dy_2}{\int_{T_k}^{\infty} f(y_2/H_1) dy_2 - \int_{T_{k-1}}^{\infty} f(y_2/H_1) dy_2}, k=2,3,\dots,N \quad (3.25)$$

Equivalently we can write (3.25) in the form

$$\Lambda(X_k) = C \frac{\int_{T_k}^{T_{k-1}} f(y_2/H_0) dy_2}{\int_{T_k}^{T_{k-1}} f(y_2/H_1) dy_2}, k=2,3,\dots,N. \quad (3.26)$$

P_d and P_f in this case are given by

$$P_d = \sum_{i=1}^N \int_{X_i}^{X_{i+1}} f(y_1/H_1) dy_1 \int_{T_i}^{\infty} f(y_2/H_1) dy_2 \quad (3.27)$$

and

$$P_f = \sum_{i=1}^N \int_{X_i}^{X_{i+1}} f(y_1/H_0) dy_1 \int_{T_i}^{\infty} f(y_2/H_0) dy_2 \quad (3.28)$$

Equations (3.24) and (3.26) are only necessary conditions for optimality for monotonic likelihood ratio. They correspond to minima if the Hessian matrix $[\partial^2 R / \partial X_i \partial X_j]$ is positive definite. All solutions must be checked for the global minima.

4. Solution of the Primary Decision Maker Problem with Independent Sensor Observations and Monotonic Likelihood Ratio

The following theorem summarizes the above solution of the PDM with independent sensor observations and monotonic likelihood ratio.

Theorem 3.2

The decision rule of the Primary Decision Maker with a Quantized Consultant (for independent sensor observations and monotonic likelihood ratio) is;

1. deterministic

$$\gamma_2 : Y_{1q} \times Y_2 \rightarrow (0, 1) \quad (3.29)$$

2. a likelihood ratio test

$$u_o = \begin{cases} 1 & \text{if } \Lambda(y_2) \geq \Theta_j \\ 0 & \text{if } \Lambda(y_2) < \Theta_j \end{cases}, j=1,2,\dots,N \quad (3.30)$$

where $\Lambda(y_2) = f(y_2/H_1)/f(y_2/H_0)$

3. the threshold function $\Theta(y_2)$ is given by

$$\Theta_j = C \frac{\int_{X_i}^{X_{j+1}} f(y_1/H_0) dy_1}{\int_{X_j}^{X_{j+1}} f(y_1/H_1) dy_1}, j=1,2,\dots,N. \quad (3.31)$$

The optimum set of quantizer interval end points must satisfy the set (3.26), where T_k 's are given by (3.24). All possible solutions must be checked for the global minimum cost.

5. The Case of Correlated Observations

We now move to a more realistic situation by removing the condition of independent sensor observations. In many radar and sonar problems noise in nearby sensors is likely to be correlated. As we mentioned before the decision rules (3.11) are likelihood ratio tests with data dependent thresholds. It is impossible to come with their optimum functional expressions [4.] A suboptimal solution for the case of correlated observations is to use likelihood ratio tests with constant thresholds as local decision rules. These constant thresholds for y_2 are the values of y_2 for which the inequality (3.11) is an equality. i.e.;

$$\Lambda(T_k) = C \frac{\int_{X_k}^{X_{k+1}} f(y_1/T_k, H_0) dy_1}{\int_{X_k}^{X_{k+1}} f(y_1/T_k, H_1) dy_1}, k=1,2,\dots,N. \quad (3.32)$$

In terms of these thresholds T_k 's and the quantizer points X_k 's one can write expressions for the probability of detection and the probability of false alarm in the form of (3.4) and (3.5). Substituting for P_d and P_f in (3.3) and differentiating R with respect to X_k for $k=2,3,\dots,N$ yields the following set of necessary conditions for the case of monotonic $\Lambda_2(y_2)$:

$$\Lambda(X_k) = C \frac{\int_{T_k}^{T_{k-1}} f(y_2/X_k, H_0) dy_2}{\int_{T_k}^{T_{k-1}} f(y_2/X_k, H_1) dy_2}, k=2,3,\dots,N. \quad (3.33)$$

The set of equations in (3.32) and (3.33) constitute $2N-1$ equations that specify the quantizer interval end points $\{X_k\}$ for y_1 and the thresholds $\{T_k\}$ for y_2 .

C. TEAM DECISION OF TWO QUANTIZERS AND A FUSION CENTER

In this section we will consider the problem of making a global decision based on two quantized observations.

1. Formulation of the QD problem

For the structure of Figure 3.2, y_1 is quantized into N levels by the quantization rule α_1

$$\alpha_1 : Y_1 \rightarrow Y_{1q} \quad (3.34)$$

and y_2 is quantized into M levels by the quantization rule α_2

$$\alpha_2 : Y_2 \rightarrow Y_{2q}. \quad (3.35)$$

The quantized values y_{1q} and y_{2q} are sent to the fusion center which must decide which state of the phenomena is true. It is required to design the quantization rules α_1 and α_2 and the decision rule γ

$$\gamma : Y_{1q} \times Y_{2q} \rightarrow (0,1) \quad (3.36)$$

to minimize the global cost.

2. Problem Analysis and the QD Algorithm

The observation space of the fusion center contains NM points to be divided into two decision regions. Since there are as many as 2^{NM} fusion methods, checking all of them will consume a very long time even for small values of N and M . A suboptimal solution is to approximate the threshold equation of the corresponding CD problem by a piecewise curve in the $y_1 y_2$ plane. This is illustrated in Figure 3.3.

The figure shows a schematic diagram of a CD threshold curve and its staircase approximation. The approximate curve consists of segments of straight lines connected together. The coordinates of the connecting points will play the role of the interval end points of the quantizers. Let us first write an expression for P_d and P_f in terms of these point coordinates. If this expression of the cost is minimized with respect to each coordinate there will be as many equations as the number of coordinates. Solving these equations simultaneously yields the quantizer parameters. This is the core of the QD algorithm which is summarized as follows:

1. Derive the threshold equation of the CD system.

$$\Lambda(y_1, y_2) = C \quad (3.37)$$

2. Approximate the threshold equation by a stepwise curve satisfying the N and M constraints.
3. Write an expression for the cost in terms of the curve parameters.
4. Minimize the average cost with respect to the curve parameters.

Let us illustrate how the algorithm works for the case of detection of a known signal in gaussian noise.

3. An Example: The Known Signal in Gaussian Noise

Consider Figure 3.2 when y_1 and y_2 are given by

$$\begin{aligned} H_0 : y_i &= n_i \\ H_1 : y_i &= a_i + n_i \quad , i=1,2 \end{aligned} \quad (3.38)$$

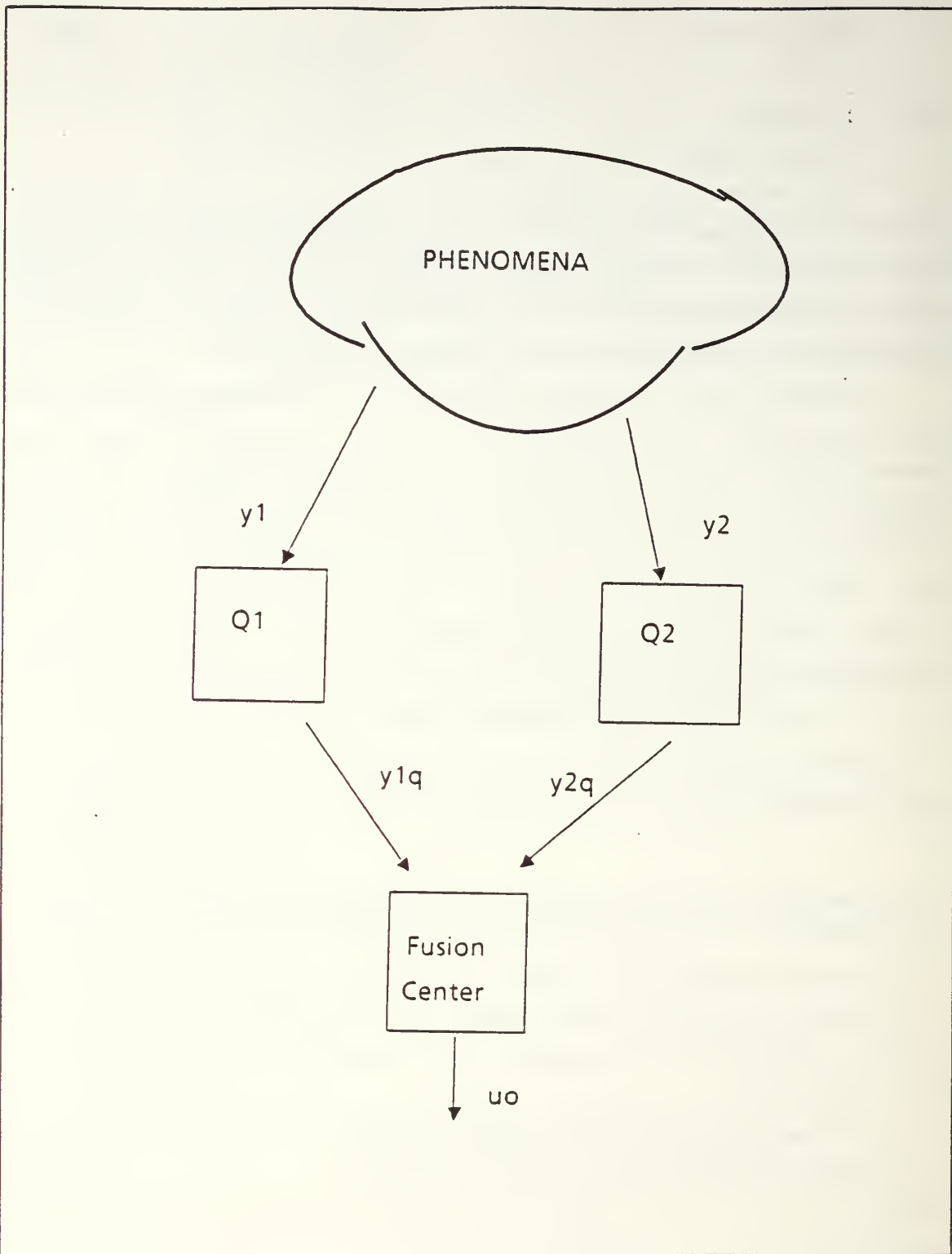

Figure 3.2 Configuration B. The Team of Two Quantizers and a Fusion Center.

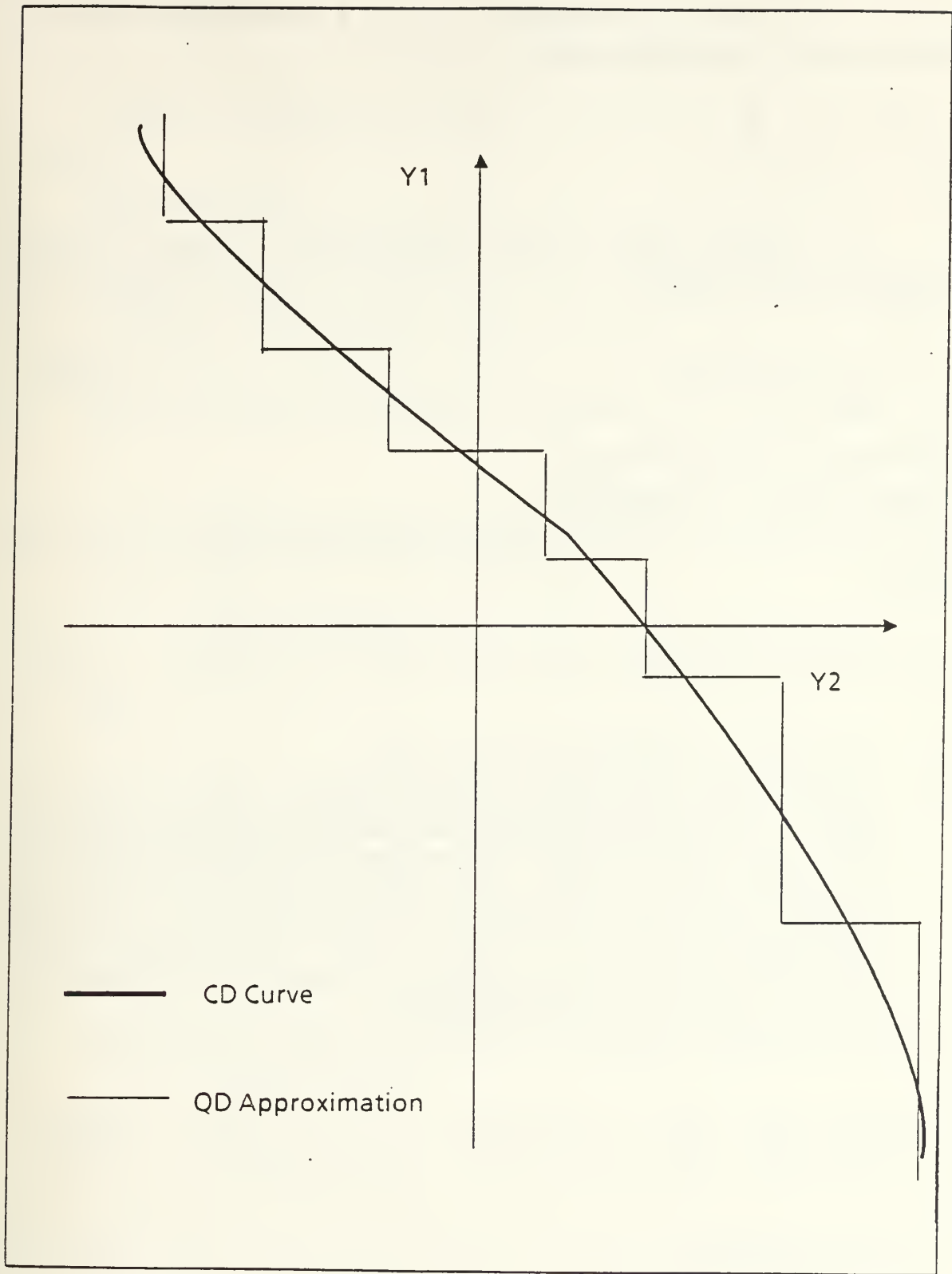

Figure 3.3 Quantized Threshold Curve.

where the a_i 's are positive constants and $\underline{N} = [n_1 \ n_2]^t$ is a gaussian random vector of zero vector mean with covariance matrix:

$$K = \begin{bmatrix} 1 & \rho \\ \rho & 1 \end{bmatrix} \quad (3.39)$$

It is required to design the N-level and the M-level quantizers Q_1 and Q_2 and the decision rule γ where

$$\gamma : Y_{1q} \times Y_{2q} \rightarrow (0,1) \quad (3.40)$$

to minimize the average decision cost.

Procedure following the QD algorithm

The threshold equation of the CD problem has been shown in Chapter II to have the form:

$$(a_1 - \rho a_2) y_1 + (a_2 + \rho a_1) y_2 = (a_1^2 + a_2^2 - \rho a_1 a_2) / 2 + (1 - \rho^2) \log(C). \quad (3.41)$$

1. The CD curve is a straight line in the $y_1 \ y_2$ plane.
2. Possible stepwise approximations for the threshold equation are shown in Figure 3.4 . We notice that in Figure 3.4 a and c the two quantizers have the same number of quantizer levels. While in Figure 3.4 b and d one quantizer has one more level than the other. From Chapter II, we can expect that the constant C will decide the superiority of a or c and of b or d. We shall consider optimum parameters of Figure 3.4 a and b. Similar treatment can be considered for Figure 3.4 c and d. In Figure 3.4 a the point $X_1 = -\infty$ while T_1 is finite. In Figure 3.4 b $X_1 = -\infty$ and $T_1 = \infty$.
3. The probability of detection of the decision rule of Figure 3.4 a is given by

$$P_d = \sum_{i=1}^N \int_{X_i}^{X_{i+1}} \int_{T_i}^{\infty} f(y_1, y_2 / H_1) dy_1 dy_2 \quad (3.42)$$

and P_f is given by

$$P_f = \sum_{i=1}^N \int_{X_i}^{X_{i+1}} \int_{T_i}^{\infty} f(y_1, y_2 / H_0) dy_1 dy_2 . \quad (3.43)$$

For the detection rule of Figure 3.4 b P_d is given by :

$$P_d = \sum_{i=2}^N \int_{X_i}^{X_{i+1}} \int_{T_i}^{\infty} f(y_1, y_2 / H_1) dy_1 dy_2 \quad (3.44)$$

and P_f is given by

$$P_f = \sum_{i=2}^N \int_{X_i}^{X_{i+1}} \int_{T_i}^{\infty} f(y_1, y_2 / H_0) dy_1 dy_2 \quad (3.45)$$

4. Necessary conditions for optimality of parameters of the curve in Figure 3.4 a are:

$$\Lambda(T_i) = C \frac{\int_{X_i}^{X_{i+1}} f(y_1 / T_i, H_0) dy_1}{\int_{X_i}^{X_{i+1}} f(y_1 / T_i, H_1) dy_1}, i = 1, 2, \dots, N \quad (3.46)$$

and

$$\Lambda(X_i) = C \frac{\int_{T_i}^{T_{i-1}} f(y_2 / X_i, H_0) dy_2}{\int_{T_i}^{T_{i-1}} f(y_2 / X_i, H_1) dy_2}, i = 2, 3, \dots, N. \quad (3.47)$$

For Figure 3.4 b, the optimality conditions are

$$\Lambda(T_i) = C \frac{\int_{X_i}^{X_{i+1}} f(y_1 / T_i, H_0) dy_1}{\int_{X_i}^{X_{i+1}} f(y_1 / T_i, H_1) dy_1}, i = 2, 3, \dots, N \quad (3.48)$$

and

$$\Lambda (X_i) = C \frac{\int_{T_i}^{T_{i-1}} f(y_2/X_i, H_0) dy_2}{\int_{T_i}^{T_{i-1}} f(y_2/X_i, H_1) dy_2}, i=2,3,\dots,N. \quad (3.49)$$

The last two equations are exactly the same as the necessary conditions for optimizing detection using a Primary Decision Maker and its quantized second opinion for the same signals in gaussian noise. Recall that the information available at the PDM is more complete than that available at the fusion center of two quantized observations. Yet the two problems have the same solution. This is a proof of the following lemma.

Lemma 3.2

Optimum detection of known signal in gaussian noise using two quantized observations of N and $N+1$ levels is equivalent to optimum detection using the first quantized observation and the second continuous observation.

Lemma 3.2 is applicable to any case with a monotonic likelihood ratio. This can be easily proved by writing the necessary conditions of optimality for the two configurations. A special case of Lemma 3.2 is that of $N = 2$. It corresponds to the tandem configuration of two detectors in a Distributed Detection Network (DDN) [10]. The "downstream" detector (decision maker) makes its decision based on its own observation and the "upstream" detector's decision.

D. NUMERICAL SOLUTION FOR THE SYSTEM PARAMETERS

It is of interest to compare the four sets of equations $\{(3.24),(3.26)\}$, $\{(3.32),(3.33)\}$, $\{(3.46),(3.47)\}$ and $\{(3.48),(3.49)\}$ with that of Lloyd and Max [18,23] for minimum distortion quantizer parameters.

Max's trial and error algorithm to solve this set of nonlinear equations can be used. However Max's algorithm is very time consuming [24]. We have used instead the method of successive substitutions with an initial guess satisfying

$$X_2 \leq X_3 \leq \dots \leq X_N \quad (3.50)$$

and put the equations in the form

$$Z = G(Z) \quad (3.51)$$

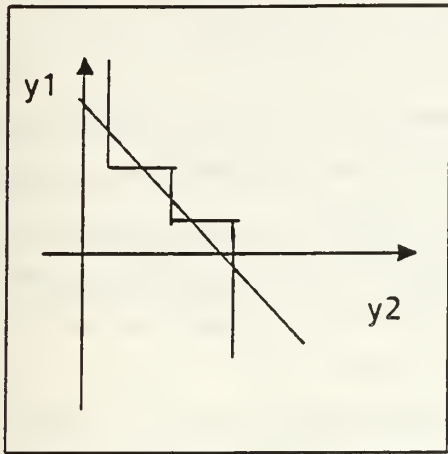

a)

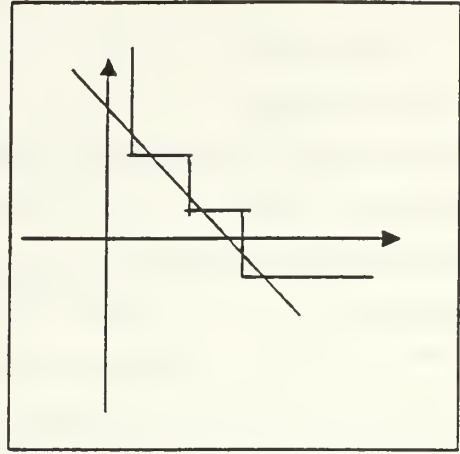

b)

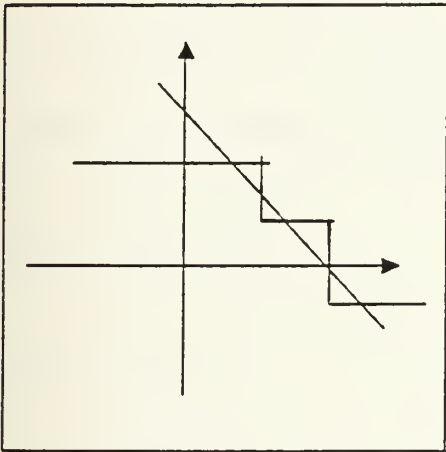

c)

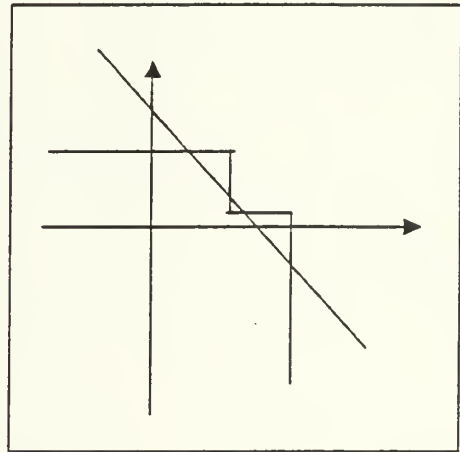

d)

Figure 3.4 Possible Approximations of the Threshold Equation.

The k th iteration is then given by

$$Z_k = G (Z_{k-1}) \quad (3.52)$$

We will devote the next chapter to solving some numerical examples using this method.

E. SUMMARY

In this chapter the method of detection using quantized sensor observations has been introduced. This method, referred to by QD, can have significant performance improvement compared to the distributed detection algorithm (DD) with only marginally more demand on the communication channels. The QD algorithm involves approximating the CD threshold hyperplane by a stepwise hyperplane that can be spanned with the quantized data and that minimizes the detection cost.

Also the equivalence between two detection configurations, one with tandem connection and the other with hierarchical structure, has been shown.

IV. NUMERICAL RESULTS

In this Chapter some examples are solved numerically using the QD algorithm. First the detection of known signals in gaussian noise is considered. Next detection of signals with exponential distribution is considered. Finally, the algorithm will be applied to differentiating between gaussian signals with different variances.

A. KNOWN SIGNAL IN GAUSSIAN NOISE

Again consider Figure 3.2 when y_1 and y_2 are given by

$$\begin{aligned} H_0 : y_i &= n_i \\ H_1 : y_i &= a_i + n_i, i=1,2 \end{aligned} \quad (4.1)$$

with $a_1 = 4$ and $a_2 = 2$. The noise vector

$$\underline{N} = [n_1 \ n_2]^t \quad (4.2)$$

is of zero vector mean and with covariance matrix given by:

$$K = \begin{bmatrix} 1 & \rho \\ \rho & 1 \end{bmatrix} \quad (4.3)$$

where ρ is given by

$$\rho = E \{ n_1 n_2 \} . \quad (4.4)$$

It is required to:

1. Design the primary decision maker PDM and its N-level Quantizer to minimize the average decision cost. We have designated this structure configuration A.
2. Design the N-level quantizers Q_1 and Q_2 and the decision rule u_0 to minimize the average decision cost. We have designated this structure configuration B.
3. Compare the performance of the two configurations and that of the completely centralized system.

Following the algorithm we have:

1. The threshold equation for the CD problem given by,

$$(a_1 - \rho a_2)y_1 + (a_2 - \rho a_1)y_2 = (a_1^2 + a_2^2 - 2\rho a_1 a_2)/2 + (1-\rho^2)\log(C) \quad (4.5)$$

a straight line in the $y_1 y_2$ plane.

2. Figures 3.4 a and 3.4 b show the decision regions for configuration A and configuration B respectively.
3. Probability of detection P_{d1} and probability of false alarm P_{f1} of PDM are given by:

$$P_{d1} = \sum_{i=1}^N \int_{X_i}^{X_{i+1}} \frac{1}{\sqrt{2\pi}} \exp(-y_1^2/2) \operatorname{erfc} \left\{ \frac{T_k - a_2 - \rho(y_1 - a_1)}{\sqrt{(1-\rho^2)}} \right\} dy_1 \quad (4.6)$$

and

$$P_{f1} = \sum_{i=1}^N \int_{X_i}^{X_{i+1}} \frac{1}{\sqrt{2\pi}} \exp(-y_1^2/2) \operatorname{erfc} \left\{ \frac{T_k - \rho y_1}{\sqrt{(1-\rho^2)}} \right\} dy_1 \quad (4.7)$$

Also P_{d2} and P_{f2} of configuration B are given by:

$$P_{d2} = \sum_{i=2}^N \int_{X_i}^{X_{i+1}} \frac{1}{\sqrt{2\pi}} \exp(-y_1^2/2) \operatorname{erfc} \left\{ \frac{T_k - a_2 - \rho(y_1 - a_1)}{\sqrt{(1-\rho^2)}} \right\} dy_1 \quad (4.8)$$

and

$$P_{f2} = \sum_{i=2}^N \int_{X_i}^{X_{i+1}} \frac{1}{\sqrt{2\pi}} \exp(-y_1^2/2) \operatorname{erfc} \left\{ \frac{T_k - \rho y_1}{\sqrt{(1-\rho^2)}} \right\} dy_1 \quad (4.9)$$

4. For configuration A equations of the quantizer interval end points and corresponding PDM's thresholds for the gaussian case are given by

$$\Lambda(X_k) = C \frac{\operatorname{erfc} \left\{ \frac{T_{k-1} - \rho X_k}{\sqrt{(1-\rho^2)}} \right\} - \operatorname{erfc} \left\{ \frac{T_k - \rho X_k}{\sqrt{(1-\rho^2)}} \right\}}{\operatorname{erfc} \left\{ \frac{T_{k-1} - a_2 - \rho(X_k - a_1)}{\sqrt{(1-\rho^2)}} \right\} - \operatorname{erfc} \left\{ \frac{T_k - a_2 - \rho(X_k - a_1)}{\sqrt{(1-\rho^2)}} \right\}} \quad , k = 2, 3, \dots, N$$

and

$$\Lambda(T_k) = C \frac{\operatorname{erfc}\left\{\frac{X_{k+1} - \rho T_k}{\sqrt{(1-\rho^2)}}\right\} - \operatorname{erfc}\left\{\frac{X_k - \rho T_k}{\sqrt{(1-\rho^2)}}\right\}}{\operatorname{erfc}\left\{\frac{X_{k+1} - a_1 - \rho(T_k - a_2)}{\sqrt{(1-\rho^2)}}\right\} - \operatorname{erfc}\left\{\frac{X_k - a_1 - \rho(T_k - a_2)}{\sqrt{(1-\rho^2)}}\right\}} \quad ,k=1,2, N. \quad (4.11)$$

For configuration B the quantizer end point intervals X's and T's are given by:

$$\Lambda(X_k) = C \frac{\operatorname{erfc}\left\{\frac{T_{k-1} - \rho X_k}{\sqrt{(1-\rho^2)}}\right\} - \operatorname{erfc}\left\{\frac{T_k - \rho X_k}{\sqrt{(1-\rho^2)}}\right\}}{\operatorname{erfc}\left\{\frac{T_{k-1} - a_2 - \rho(X_k - a_1)}{\sqrt{(1-\rho^2)}}\right\} - \operatorname{erfc}\left\{\frac{T_k - a_2 - \rho(X_k - a_1)}{\sqrt{(1-\rho^2)}}\right\}} \quad ,k=2,3, N \quad (4.12)$$

and

$$\Lambda(T_k) = C \frac{\operatorname{erfc}\left\{\frac{X_{k+1} - \rho T_k}{\sqrt{(1-\rho^2)}}\right\} - \operatorname{erfc}\left\{\frac{X_k - \rho T_k}{\sqrt{(1-\rho^2)}}\right\}}{\operatorname{erfc}\left\{\frac{X_{k+1} - a_1 - \rho(T_k - a_2)}{\sqrt{(1-\rho^2)}}\right\} - \operatorname{erfc}\left\{\frac{X_k - a_1 - \rho(T_k - a_2)}{\sqrt{(1-\rho^2)}}\right\}} \quad ,k=2,3, N. \quad (4.13)$$

We have solved the system of equations of the two configurations using the method of successive substitution for $N = 2, 3, 4, 5$ and 6 . Figure 4.1 shows the receiver operating characteristics ROC for the two configurations for $\rho=0$, for different values of N . The ROC for the CD system is also shown. The effect of ρ is illustrated in Figure 4.2. The figure shows ROC curves for Configuration A for different values of N and for $\rho=0$ and 0.25 . Figure 4.3 shows the average cost of Configuration B and CD vs. C , for different values of N . The relation between the cost of detection for Configuration B vs. the number of quantization levels is shown in Figure 4.4. The figure shows the exponential decay of the detection cost as the amount of information available at the fusion center increases.

The following results are noted from the curves.

1. Configuration A has better ROC curves than Configuration B. The performance difference is large for $N = 2$ but gets smaller as N increases.
2. Both performances converge to that of the CD in a uniform manner.
3. As the correlation coefficient increases the performance difference decreases.

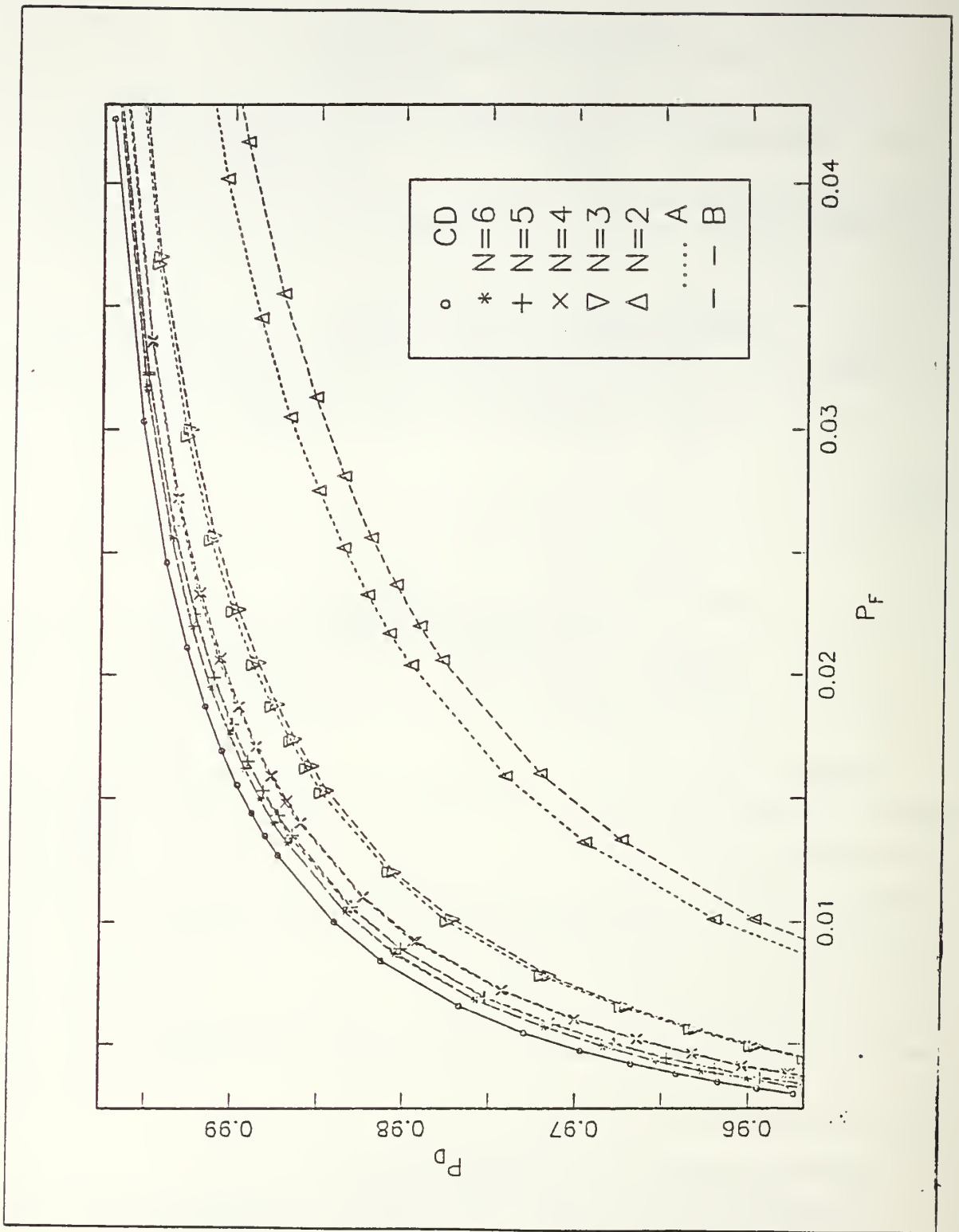

Figure 4.1 ROC Curves for Configuration A , Configuration B and CD.

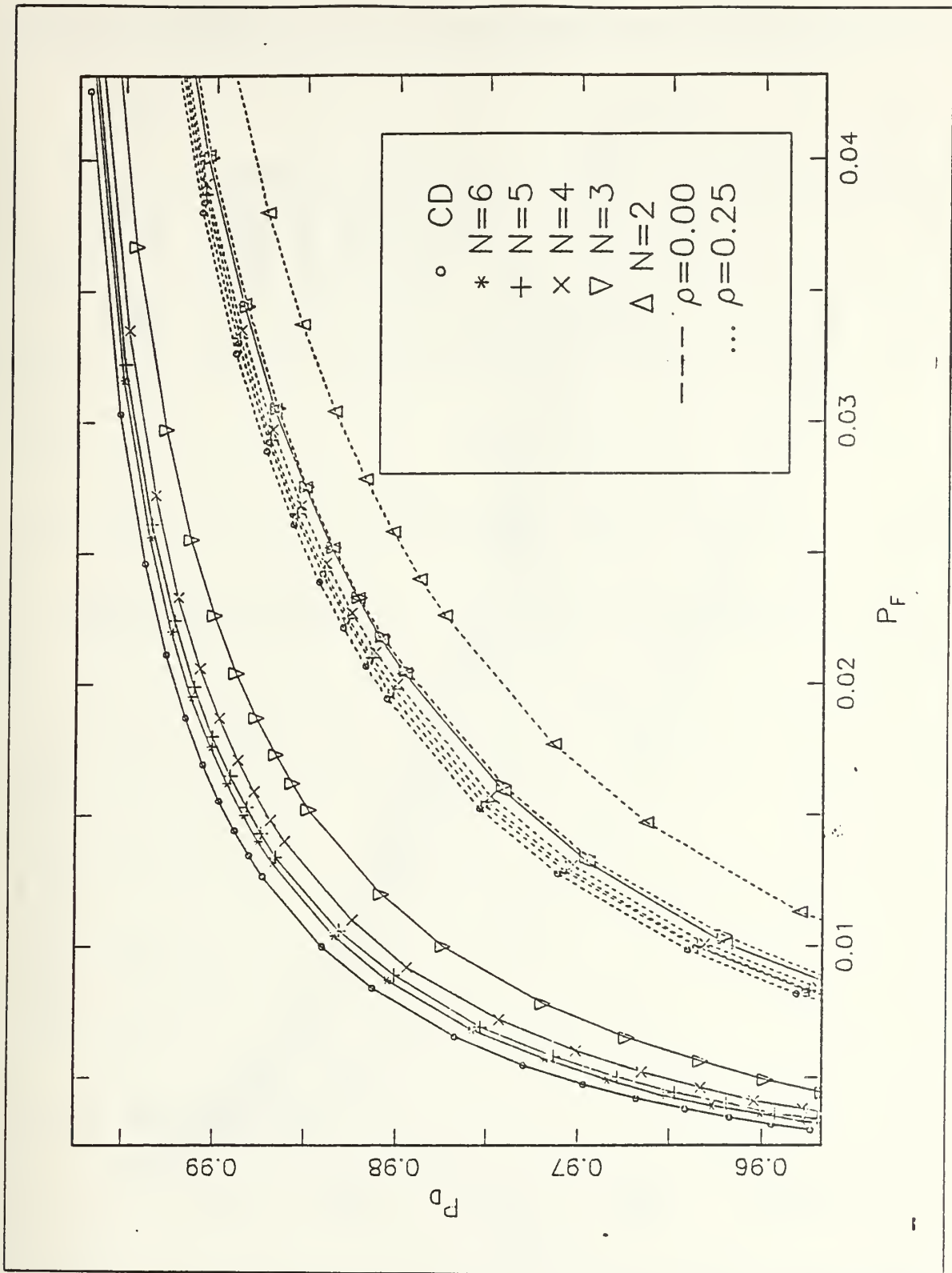

Figure 4.2 ROC Curves for Configuration A for $\rho = 0$ and 0.25.

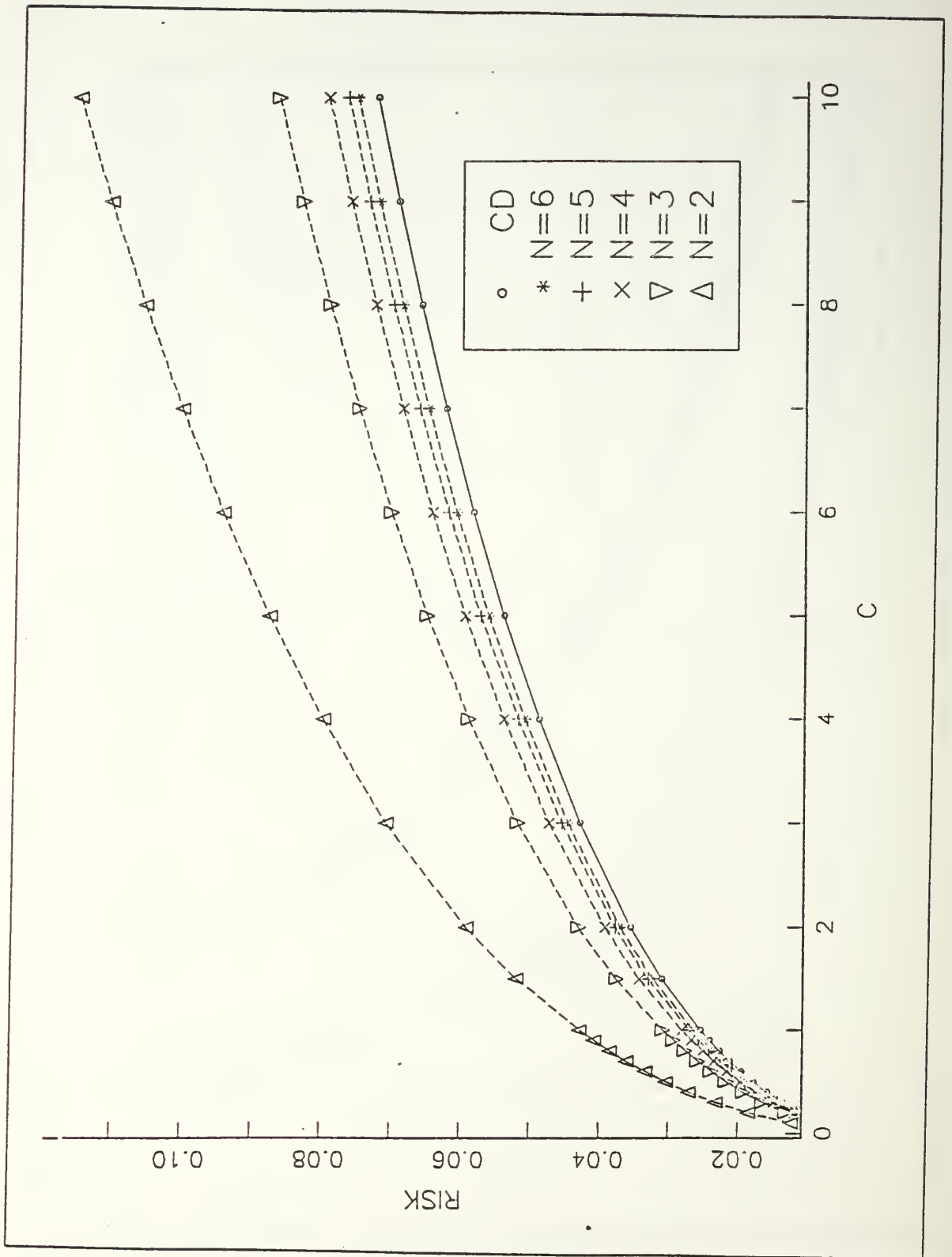

Figure 4.3 Average Detection Cost for Configuration B and CD.

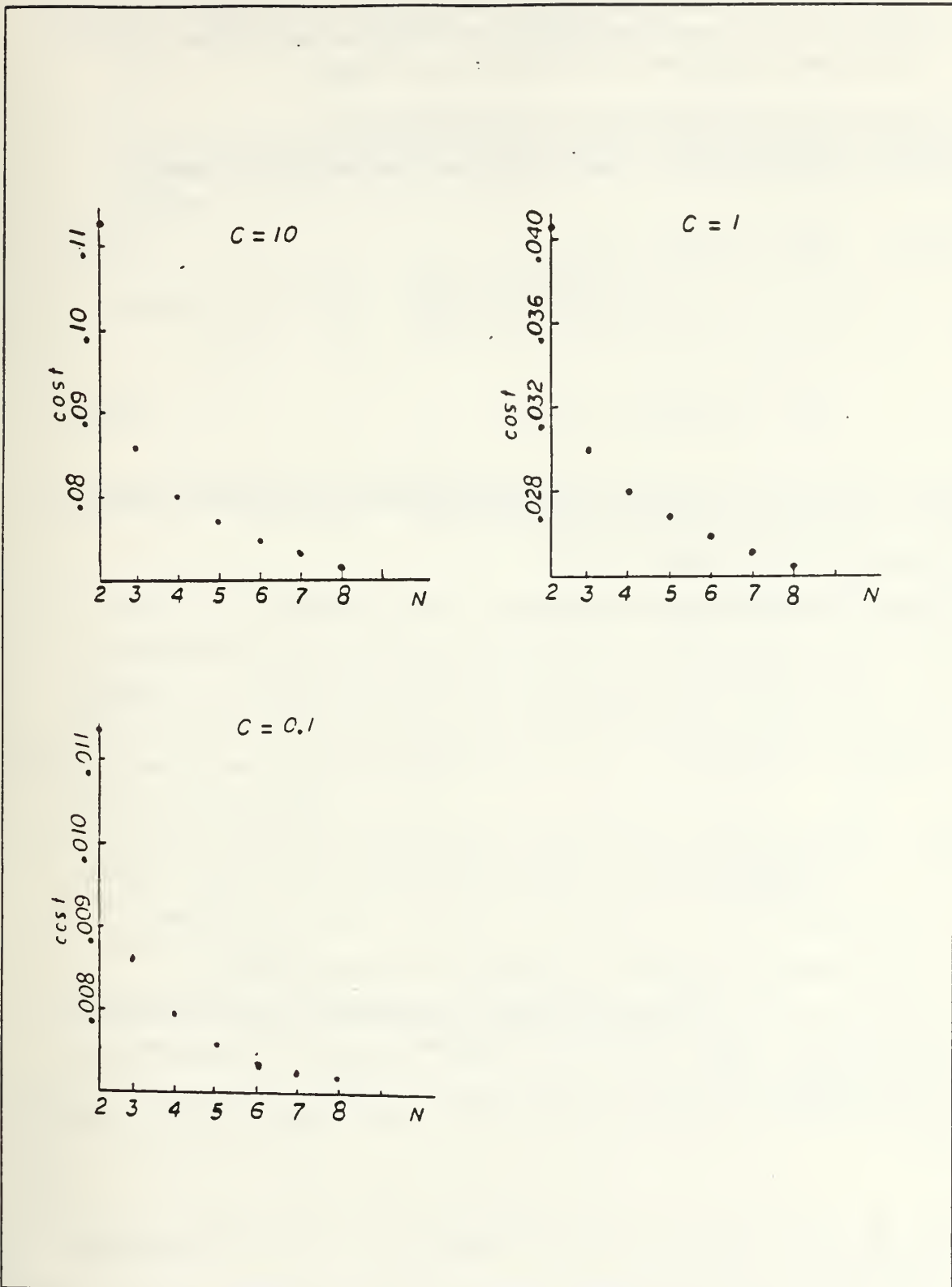

Figure 4.4 Average detection cost for Configuration B vs. N .

4. As N increases the average detection cost gets smaller and tends to that of the CD. Since the number N reflects the mutual information between the input and the output of the quantizers, the relation between the performance degradation and information delivered to the fusion center is strong.

B. SIGNALS WITH EXPONENTIAL DISTRIBUTIONS

Consider again Figure 3.2 . Let y_1 and y_2 have the following distributions:

$$H_0 : \quad f(y_i) = \lambda_0 \exp(-\lambda_0 y_i) \quad (4.14)$$

and

$$H_1 : \quad f(y_i) = \lambda_1 \exp(-\lambda_1 y_i) , i=1,2 \quad (4.15)$$

and assume that λ_1 is less than λ_0 . It is required to design the quantizers and fusion rule that minimize the average decision cost.

Following the QD algorithm we have:

1. The CD threshold equation is given by

$$y_1 + y_2 = C_1 \quad (4.16)$$

where C_1 is given by

$$C_1 = \frac{(\lambda_0 / \lambda_1)^2}{\lambda_0 - \lambda_1} C . \quad (4.17)$$

The CD threshold equation is a straight line in the first quadrant.

2. Figure 4.5 shows possible approximations of the threshold equation. For $N=2$, the symmetry suggests equal detector thresholds. For $N \geq 3$ let us fix X_1 and T_N to zero.
3. The probability of detection and probability of false alarm P_d and P_f are given by

$$P_d = \sum_{i=1}^N [\exp(-\lambda_1 X_i) - \exp(-\lambda_1 X_{i+1})] \exp(-\lambda_1 T_i) \quad (4.18)$$

and

$$P_f = \sum_{i=1}^N [\exp(-\lambda_0 X_i) - \exp(-\lambda_0 X_{i+1})] \exp(-\lambda_0 T_i) \quad (4.19)$$

4. Writing an expression of the average cost in P_d and P_f as before and minimizing with respect to X_k , $k=2,3,\dots,N$ and T_k , $k=1,2,\dots,N-1$ one obtains the set of equations

$$\exp\{(\lambda_0 - \lambda_1)T_k\} = \frac{\lambda_0}{\lambda_1} C \frac{\exp(-\lambda_0 X_k) - \exp(-\lambda_0 X_{k+1})}{\exp(-\lambda_1 X_k) - \exp(-\lambda_1 X_{k+1})}, k=1,2,\dots,N-1 \quad (4.20)$$

and

$$\exp\{(\lambda_0 - \lambda_1)X_k\} = \frac{\lambda_0}{\lambda_1} C \frac{\exp(-\lambda_0 T_k) - \exp(-\lambda_0 T_{k+1})}{\exp(-\lambda_1 T_k) - \exp(-\lambda_1 T_{k+1})}, k=2,3,\dots,N. \quad (4.21)$$

This set of equations have been solved by the method of successive substitutions for $\lambda_0 = 2$, $\lambda_1 = 1$, and for $N=2,3,4,5$ and 6. A FORTRAN program to calculate the quantizer parameters is given in Appendix D.

Figure 4.6 shows ROC curves for the quantized as well as the CD systems. The average detection cost is shown in Figure 4.7.

We note the following:

1. The largest performance improvement occurs when we switch from $N = 2$ to $N = 3$ (i.e. only less than one more information bit per detection).
2. The performance curves $\{ \text{ROC}(N) \}$ and $\{ R(N) \}$ converge uniformly to the performance of CD

C. GAUSSIAN SIGNALS WITH DIFFERENT VARIANCE

Consider again the structure of Figure 3.2. Let sensor observations y_1 and y_2 be independent, identically distributed gaussian random variables of zero mean. However,

$$\text{under } H_0, \text{Var}(y_i) = \sigma_0^2,$$

and

$$\text{under } H_1, \text{Var}(y_i) = \sigma_1^2, i=1,2. \text{ For specificity, let}$$

$$\sigma_0 = 1 \text{ and } \sigma_1 = \sqrt{2}.$$

Quantized sensor observations are sent to the fusion center to decide which of the hypothesis is true. It is required to design the quantizers Q_1 and Q_2 as well as the fusion rule to minimize the average decision cost.

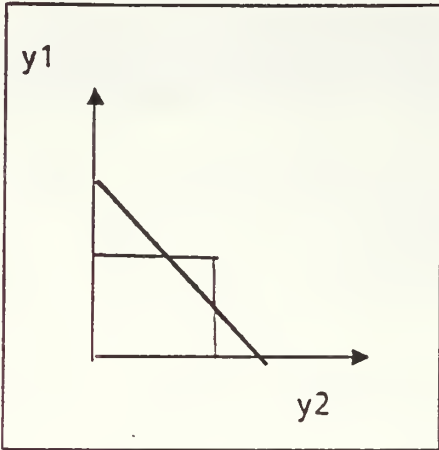

a) $N = 2$

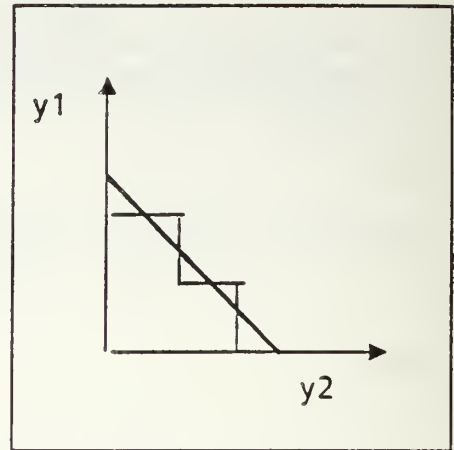

b) $N = 3$

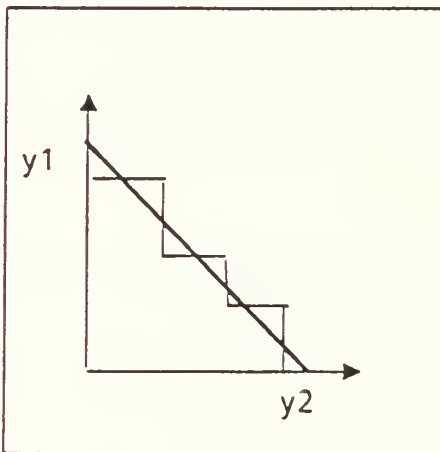

c) $N = 4$

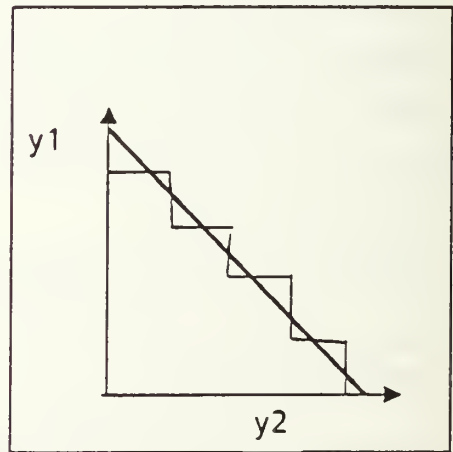

d) $N = 5$

Figure 4.5 Approximation of the Threshold equation for Different Values of N , for Exponential Signals.

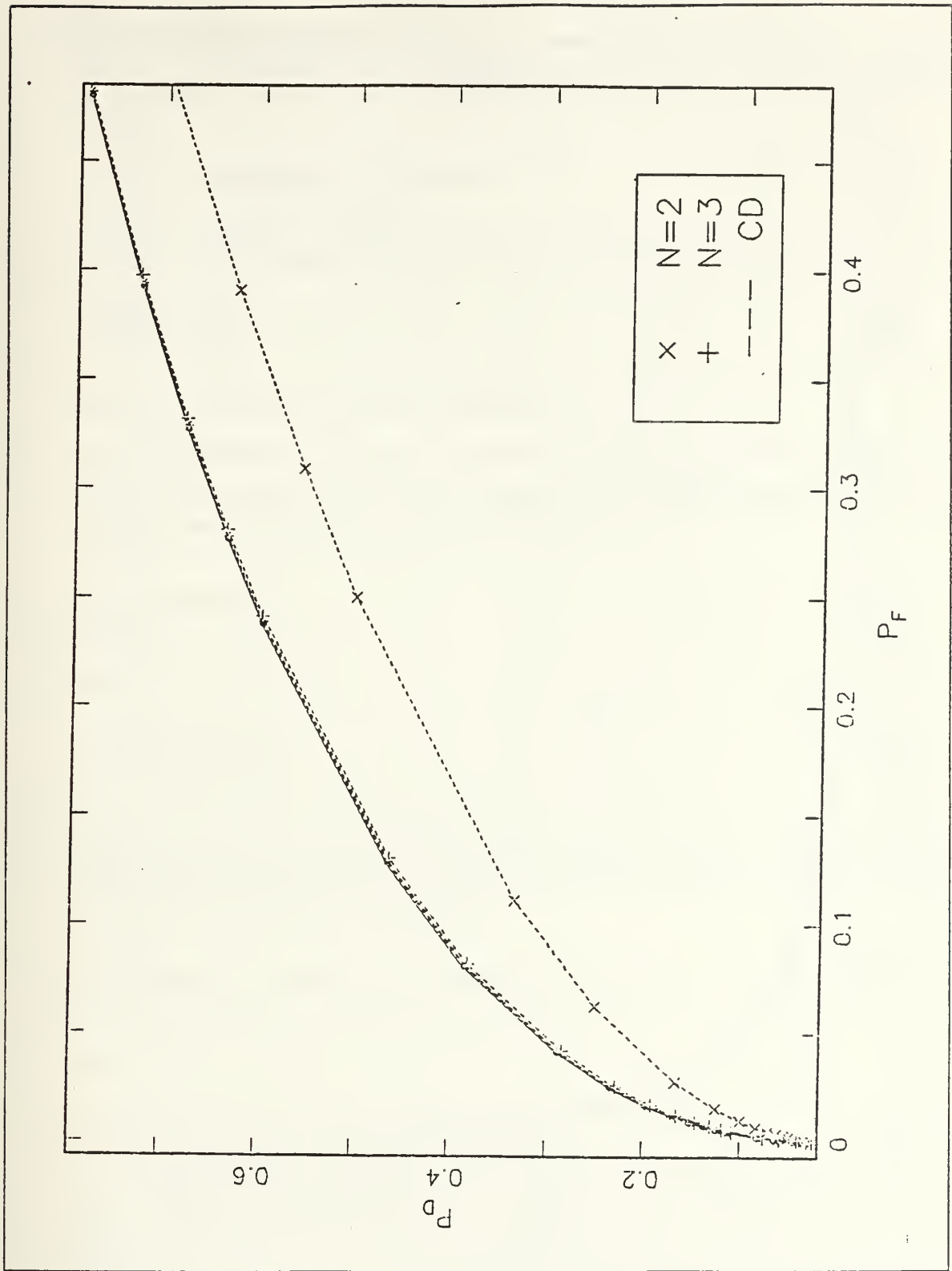

Figure 4.6 ROC curves for Exponential Signals.

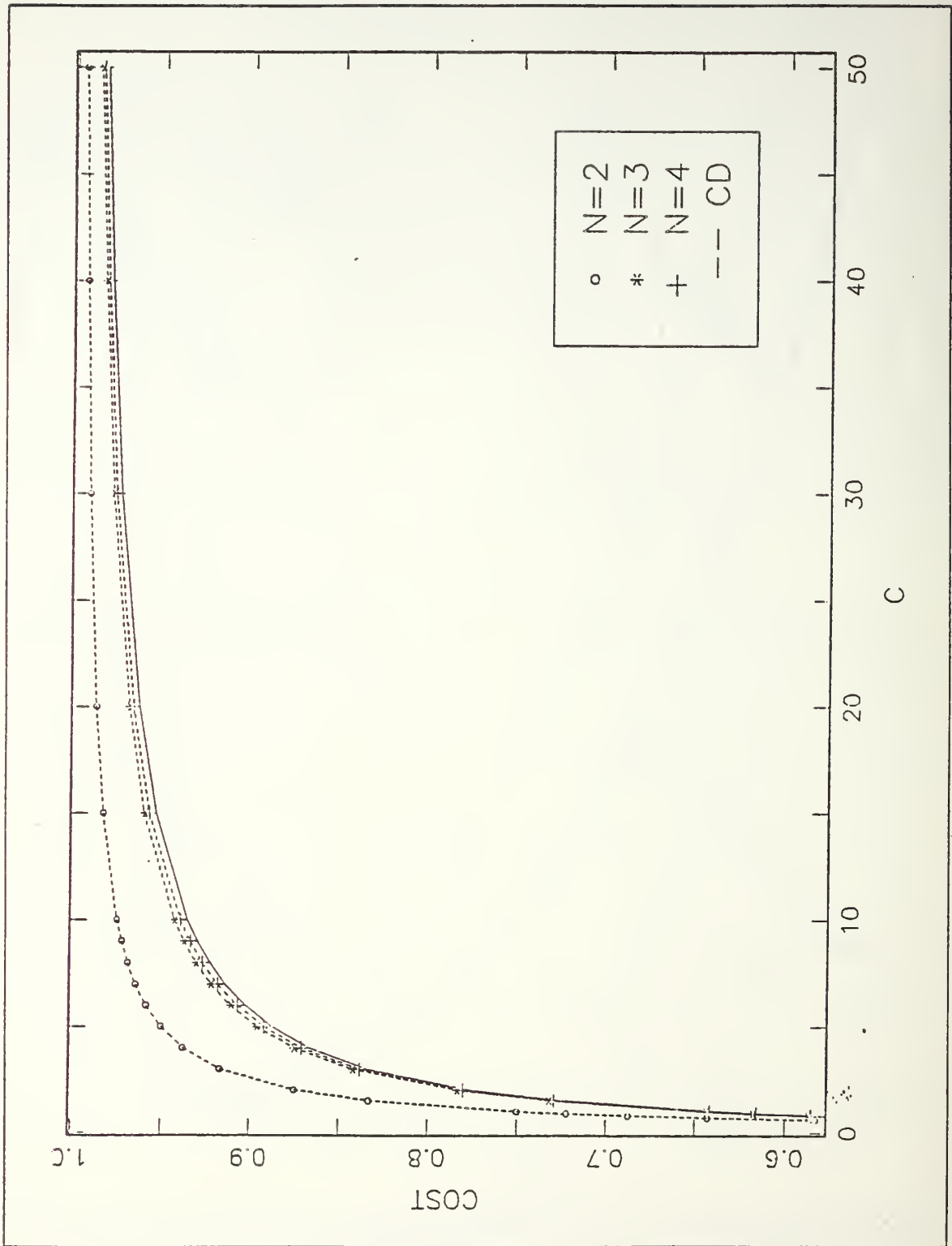

Figure 4.7 Average Detection Cost for Different Values of N for Exponential Signals.

Following the QD algorithm we have:

1. The CD system decision rule is a likelihood ratio test. The CD detector declares H_1 is true if

$$y_1^2 + y_2^2 < (1/2)\log[\sigma_1^2 / (\sigma_0^2 C)] / (\sigma_0^{-2} - \sigma_1^{-2})^{-1} \quad (4.22)$$

otherwise it will declare H_0 is true. The threshold equation is the circle

$$y_1^2 + y_2^2 = R_0^2 \quad (4.23)$$

where R_0^2 is the right hand side of inequality (4.22).

2. Possible approximations of the CD threshold equation are shown in Figure 4.8 .
3. Figure 4.8 a corresponds to 3-level quantizers. The corresponding probability of detection and probability of false alarm are given by;

$$P_d(3) = [\text{erf}(-X/\sigma_1)]^2 \quad (4.24)$$

and

$$P_f(3) = [\text{erf}(-X/\sigma_0)]^2 \quad (4.25)$$

where y_1 and y_2 are subdivided by the points X and $-X$. For the 5-level quantization approximation of Figure 4.8 b, the probability of detection and probability of false alarm are given by

$$P_d(5) = \text{erf}(X_3/\sigma_1) \{2\text{erf}(X_2/\sigma_1) - \text{erf}(X_3/\sigma_1)\} \quad (4.26)$$

and

$$P_f(5) = \text{erf}(X_3/\sigma_0) \{2\text{erf}(X_2/\sigma_0) - \text{erf}(X_3/\sigma_0)\} \quad (4.27)$$

where X_2 , X_3 , $-X_3$ and $-X_2$ define the the quantization intervals of both y_1 and y_2 .

4. Inserting $P_f(3)$ and $P_d(3)$ into R in (3.3) and minimizing R with respect to X gives

$$\Lambda(X) = C \frac{\sigma_1}{\sigma_0} \frac{\text{erf}(X/\sigma_0)}{\text{erf}(X/\sigma_1)} \quad (4.28)$$

Also inserting $P_d(5)$ and $P_f(5)$ into (3.3) and minimizing R with respect to X_2 and X_3 gives;

$$\Lambda(X_2) = C \frac{\sigma_1}{\sigma_0} \frac{\text{erf}(X_3/\sigma_0)}{\text{erf}(X_3/\sigma_1)} \quad (4.29)$$

$$\Lambda(X_3) = C \frac{\sigma_1}{\sigma_0} \frac{\text{erf}(X_2/\sigma_0) - \text{erf}(X_3/\sigma_0)}{\text{erf}(X_2/\sigma_1) - \text{erf}(X_3/\sigma_1)} \quad (4.30)$$

Solution of these implicit equations in the quantizer parameters can be carried out by the method of successive substitution. The FORTRAN program to calculate them for any value of σ_0 and σ_1 is given in Appendix F.

Figure 4.9 shows the average detection cost vs. C for 3-level and 5-level quantizer systems. Detection cost of CD is also shown. The figure shows that the detection cost decreases dramatically using 5-level quantizers in comparison to 3-level quantizers. The cost of the CD system is only slightly lower than that of the 5-level quantizers.

Similar procedures can be carried out for the case of correlated observations. The CD curve in this case is an ellipse with principle axes passing through the origin. It can be approximated in a similar way as the circle.

D. CONCLUSION

The above examples show the uniform convergence of the Quantized Detection Algorithm to the Centralized Detection Algorithm. The Distributed Detection Algorithm is a special case of QD. It follows that Quantized Detection is an efficient utilization of bandlimited communication channels.

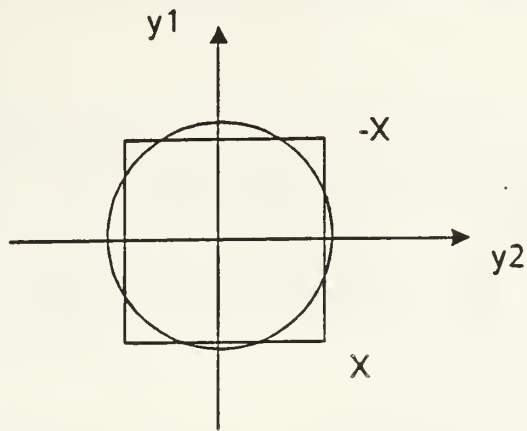

a) Approximation with 3 Levels

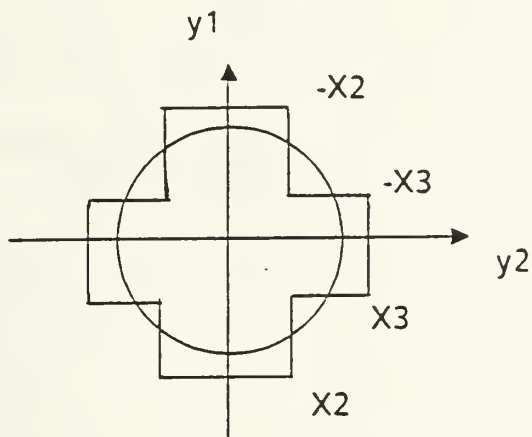

b) Approximation with 5 Levels

Figure 4.8 Possible Approximation Of the Threshold Equation.

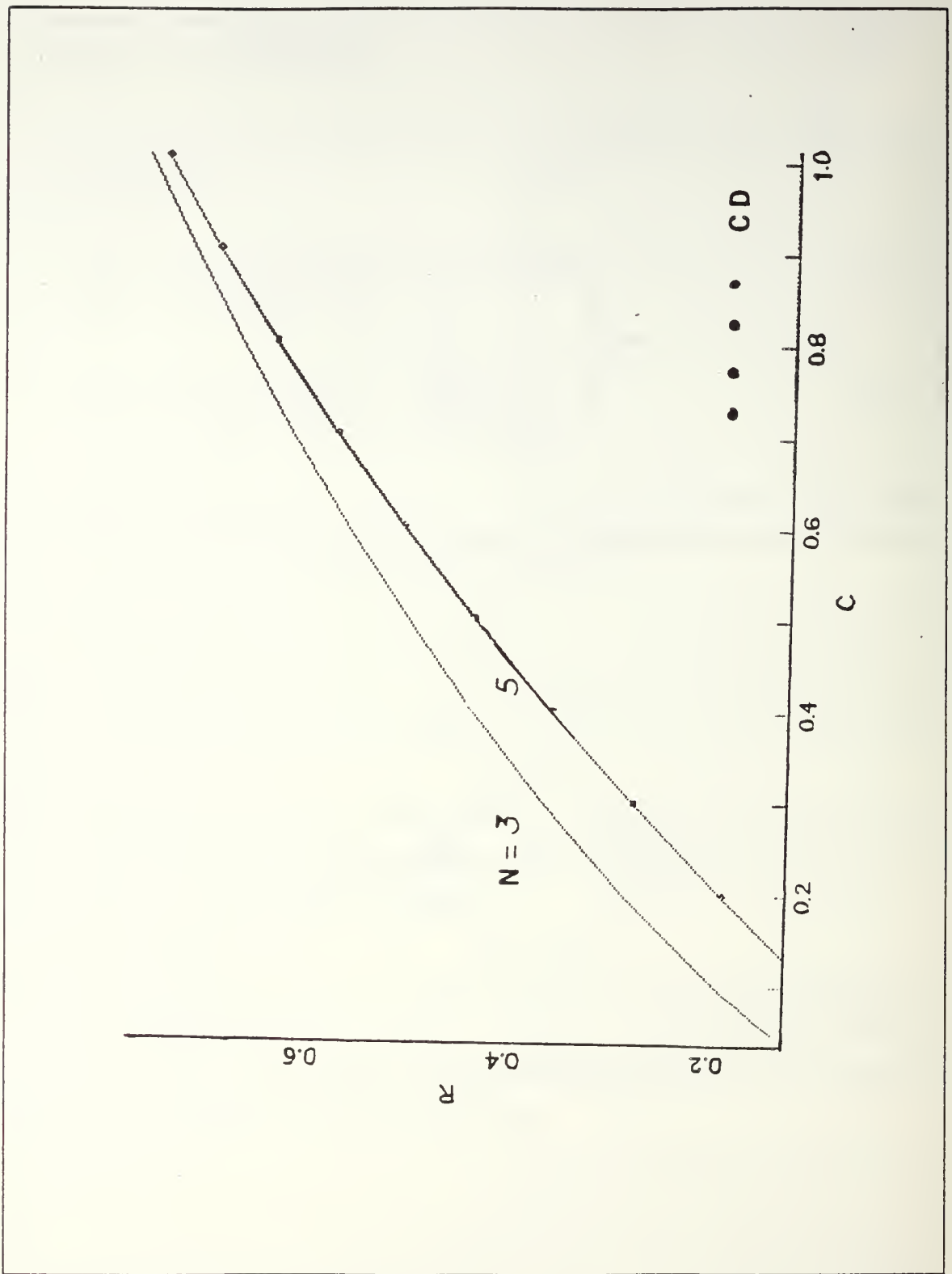

Figure 4.9 Average Detection Cost.

V. THE CASE OF VECTOR OBSERVATIONS

A. INTRODUCTION

In the previous two chapters the QD problem for the case of scalar sensor observations was solved. It is now time to extend the QD algorithm to the case where each local observation is a vector \underline{Y}_i . The QD algorithm can be applied as long as the corresponding sufficient statistic for the centralized detection problem can be divided into local statistics to be quantized. Let us consider the gaussian case and put it in the previous framework.

B. QUANTIZED DETECTION WITH VECTOR OBSERVATIONS

For the structure of Figure 5.1 the observations at locations 1 and 2 are given by

$$\begin{aligned} H_0 : \underline{Y}_i &= \underline{N}_i \\ \text{and} \\ H_1 : \underline{Y}_i &= \underline{A}_i + \underline{N}_i \quad , i=1,2. \end{aligned} \quad (5.1)$$

Let us denote the observation vector by \underline{Y}

$$\underline{Y} = \begin{bmatrix} \underline{Y}_1 \\ \underline{Y}_2 \end{bmatrix}. \quad (5.2)$$

The noise vector \underline{N} , given by

$$\underline{N} = \begin{bmatrix} \underline{N}_1 \\ \underline{N}_2 \end{bmatrix}, \quad (5.3)$$

is multivariate gaussian with zero vector mean and covariance

$$\underline{R} = \begin{bmatrix} \underline{R}_1 & \underline{R}_{12} \\ \underline{R}_{21} & \underline{R}_2 \end{bmatrix} \quad (5.4)$$

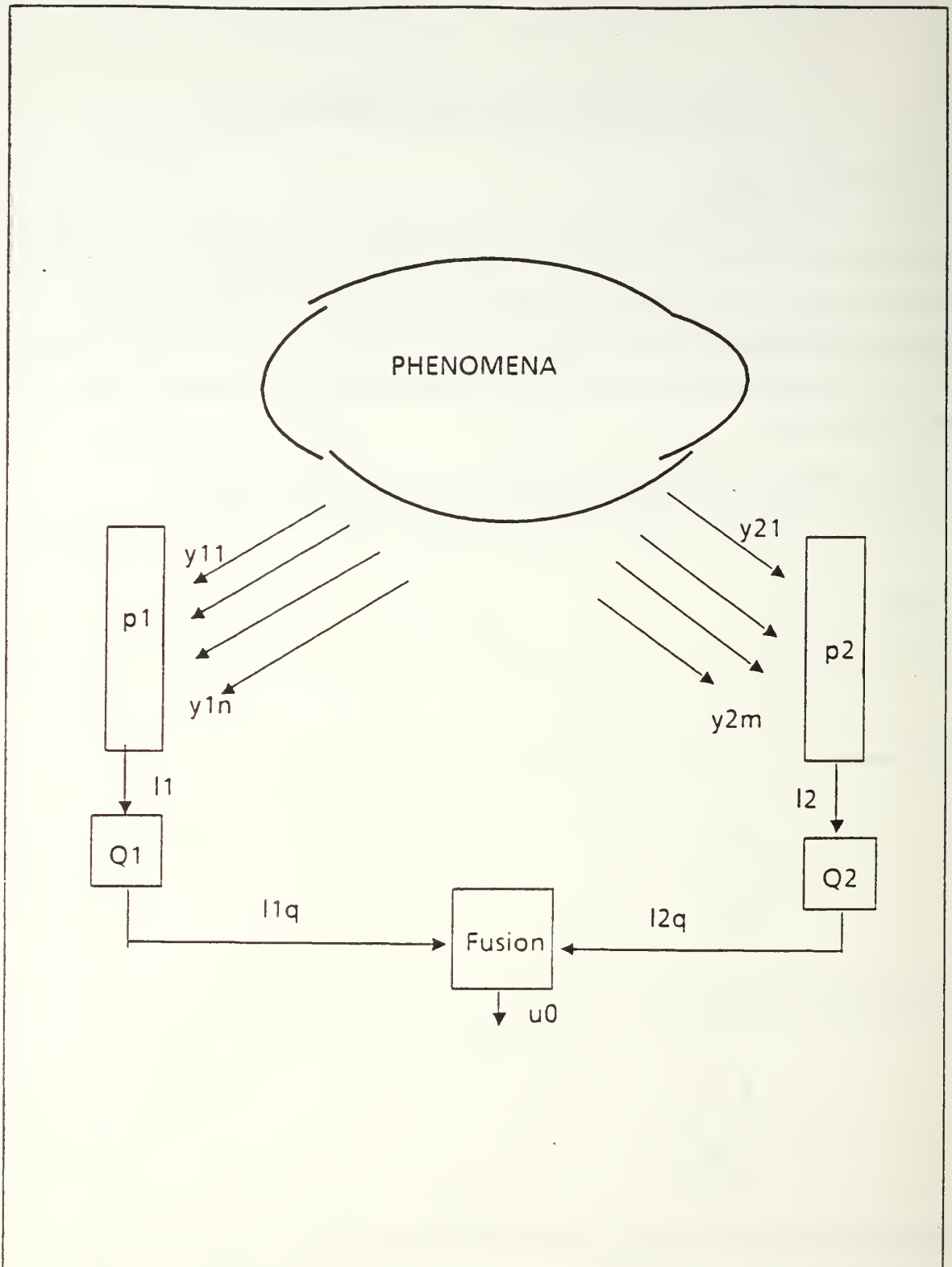

Figure 5.1 Vector Observations.

\underline{R}_1 , \underline{R}_2 and \underline{R}_{12} are the covariance matrices of the noises at locations 1 and 2 and their common covariance matrix. The signal vector \underline{A} is given by

$$\underline{A} = \begin{bmatrix} \underline{A}_1 \\ \underline{A}_2 \end{bmatrix}. \quad (5.5)$$

The CD system decides that \underline{Y} belongs to Z_1 if [6]

$$\exp \{ (-1/2) [(\underline{Y} - \underline{A})' \underline{R}^{-1} (\underline{Y} - \underline{A}) - \underline{Y}' \underline{R}^{-1} \underline{Y}] \} \geq C. \quad (5.6)$$

The CD threshold equation can be written in the form

$$\underline{A}' \underline{R}^{-1} \underline{Y} = \log(C) - (1/2) \underline{A}' \underline{R}^{-1} \underline{A}. \quad (5.7)$$

Using the block matrix inversion lemma [25], (5.7) can be written in the form

$$\alpha \underline{Y}_1 + \beta \underline{Y}_2 = \log(C) - (1/2) \underline{A}' \underline{R}^{-1} \underline{A}. \quad (5.8)$$

In (5.8) α and β are given by

$$\alpha = \underline{A}'_1 (\underline{R}_1 - \underline{R}_{12} \underline{R}_2^{-1} \underline{R}_{21})^{-1} - \underline{A}'_2 (\underline{R}_2 - \underline{R}_{21} \underline{R}_1^{-1} \underline{R}_{12})^{-1} \underline{R}_{21} \underline{R}_1^{-1} \quad (5.9)$$

and

$$\beta = -\underline{A}'_1 (\underline{R}_1 - \underline{R}_{12} \underline{R}_2^{-1} \underline{R}_{21})^{-1} \underline{R}_{12} \underline{R}_2^{-1} + \underline{A}'_2 (\underline{R}_2 - \underline{R}_{21} \underline{R}_1^{-1} \underline{R}_{12})^{-1}. \quad (5.10)$$

Denoting

$$l_1 = \alpha \underline{Y}_1 \quad (5.11)$$

and

$$l_2 = \beta \underline{y}_2 \quad (5.12)$$

(5.8) becomes

$$l_1 + l_2 = \log(C) - (1/2) \underline{A}' \underline{R}^{-1} \underline{A} \quad (5.13)$$

where l_1 and l_2 are bivariate gaussian with zero vector mean under hypothesis H_0 . Under hypothesis H_1 their vector mean is

$$E \left\{ \begin{bmatrix} l_1 \\ l_2 \end{bmatrix} \right\} = \begin{bmatrix} \alpha \underline{A}_1 \\ \beta \underline{A}_2 \end{bmatrix} . \quad (5.14)$$

Covariance of l_1 and l_2 is given by

$$\text{Cov}(l_1, l_2) = \begin{bmatrix} \alpha' \underline{R}_1 \alpha & \rho \\ \rho & \beta' \underline{R}_2 \beta \end{bmatrix} \quad (5.15)$$

In (5.15) ρ is given by

$$\rho = \alpha \underline{R}_{12} \beta \sqrt{[(\alpha \underline{R}_1 \alpha)^{-1} (\beta \underline{R}_2 \beta)^{-1}]} . \quad (5.16)$$

The distributed signal processing is to form local linear combinations l_1 and l_2 , then quantize them as before. This processing is also shown in Figure 5.1.

C. SUMMARY

In this Chapter it is shown that the QD algorithm can be extended to the case of sensor vector observations. An application is the case of high quality local area communication and lower quality long distance communications. In this case sensor observations in local areas are gathered at a local processor to form the local sufficient statistics. Quantized local statistics are then sent to the global far away processor for fusion.

VI. OPTIMUM ESTIMATION USING QUANTIZED SENSOR OBSERVATIONS

A. INTRODUCTION

In the previous part of this thesis there are situations in which a group of observers make local decisions that, taken in combination determine the overall performance of a system. The observers may or may not be interconnected. However, even when they are, for a variety of considerations such as limitations on communications bandwidth, transmitter power, security, or perhaps the very nature of the observers themselves, only decisions may be interchanged between them and not all the observations upon which their decisions are based [1,5,26-33].

Another case of interest concerns the encoding of high resolution measurements for transmission between observers using a small number of bits. Here a remote observer must decide which of N possible discrete values best represents his observation. A second observer is to combine his local observations with the discrete data from the first in an optimum manner. In this chapter we consider the problem of regeneration of a remote sensor observation using its quantized representation and a local observation. The design of the quantizer at the remote sensor location and the optimum linear estimator to combine the quantized data with the local observation to minimize the expected mean square estimation error will be considered. Generalization of the results to the vector case is also shown.

B. THE LINEAR MINIMUM MEAN-SQUARE ESTIMATE OF Y_1

Consider the structure of Figure 6.1 in which the observation y_1 is quantized into y_{1q} by a quantization rule γ

$$\gamma : y_1 \rightarrow y_{1q}. \quad (6.1)$$

The quantized data y_{1q} is sent to sensor S_2 site.

The linear minimum mean square estimate of the observation y_1 from y_{1q} and y_2 is shown in (Appendix F) to be

$$\hat{y}_1 = \left[(1 - \rho^2) \mu y_{1q} + \rho \frac{\sigma_1}{\sigma_2} (\eta - \rho^2) y_2 \right] / (\eta - \mu^2 \rho^2) \quad (6.2)$$

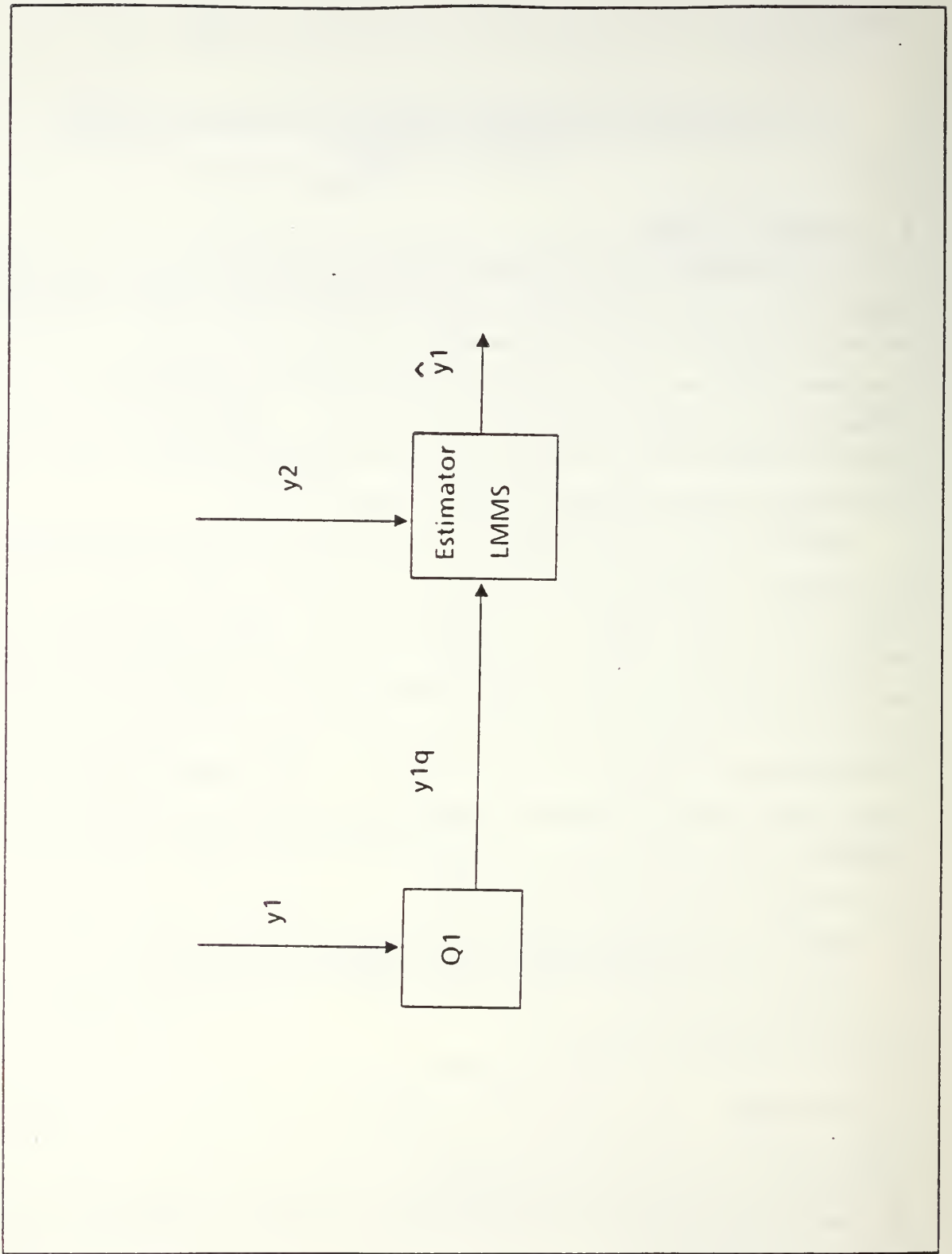

Figure 6.1 Estimation Using Quantized Sensor Observations.

where we have assumed that y_1 and y_2 are random variables with zero mean and variances

$$E\{y_i^2\} = \sigma_i^2, i=1,2 \quad (6.3)$$

and correlation

$$\rho = E\{y_1 y_2\} / \sigma_1 \sigma_2 \quad (6.4)$$

The scalar quantities η and μ are parameters of the quantizer and are given by

$$\eta = \left(\sum_{k=1}^N P_k Q_k^2 \right) / \sigma_1^2 \quad (6.5)$$

and

$$\mu = \left(\sum_{k=1}^N P_k Q_k C_k \right) / \sigma_1^2. \quad (6.6)$$

N is the number of quantization levels and C_k and P_k are given by

$$C_k = \left(\int_{X_k}^{X_{k+1}} f(y_1) dy_1 \right) / P_k \quad (6.7)$$

and

$$P_k = \int_{X_k}^{X_{k+1}} f(y_1) dy_1. \quad (6.8)$$

Q_k is the k th quantization value and $Q_k \in [X_k, X_{k+1}]$. In (6.7) and (6.8), $X_k, k=1,2,\dots,N$, are the quantization interval end points, with

$$X_1 = -\infty \text{ and } X_{N+1} = \infty.$$

It is required to design a quantizer that minimizes the mean square estimation error.

The expected mean square error is given by [34]

$$E\{(y_1 - \hat{y}_{1q})^2\} = \sigma_1^2 - E\{y_1 \underline{y}^t\} E\{\underline{y} \underline{y}^t\}^{-1} E\{\underline{y} y_1\} \quad (6.9)$$

where \underline{y} is the vector

$$\underline{y} = [y_{1q} \ y_2]^t. \quad (6.10)$$

Equation (6.9) can be written in the form (Appendix D)

$$E\{e^2\} = \sigma_1^2 (1 - \rho^2)(1 - \omega) / (1 - \rho^2 \omega) \quad (6.11)$$

where ω is given by:

$$\omega = \mu^2 / \eta. \quad (6.12)$$

A plot of $E\{e^2\} / \sigma_1^2$ vs. ω is shown in Figure 6.2 for $\rho^2 = 0, 0.25, 0.5, 0.75$. The figure shows that the mean square error is decreasing with ω . Recall that the criterion is to minimize the mean square error.

Equivalently the problem now is to maximize ω over all quantization rules where

$$\omega = \frac{1}{\sigma_1^2} \frac{(\sum_{k=1}^N P_k Q_k C_k)^2}{\sum_{k=1}^N P_k Q_k^2} \quad (6.13)$$

Applying the Cauchy Inequality [35] to the numerator yields

$$(\sum_{k=1}^N P_k Q_k C_k)^2 \leq (\sum_{k=1}^N P_k Q_k^2) (\sum_{k=1}^N P_k C_k^2) \quad (6.14)$$

with equality if and only if

$$Q_k = C_k. \quad (6.15)$$

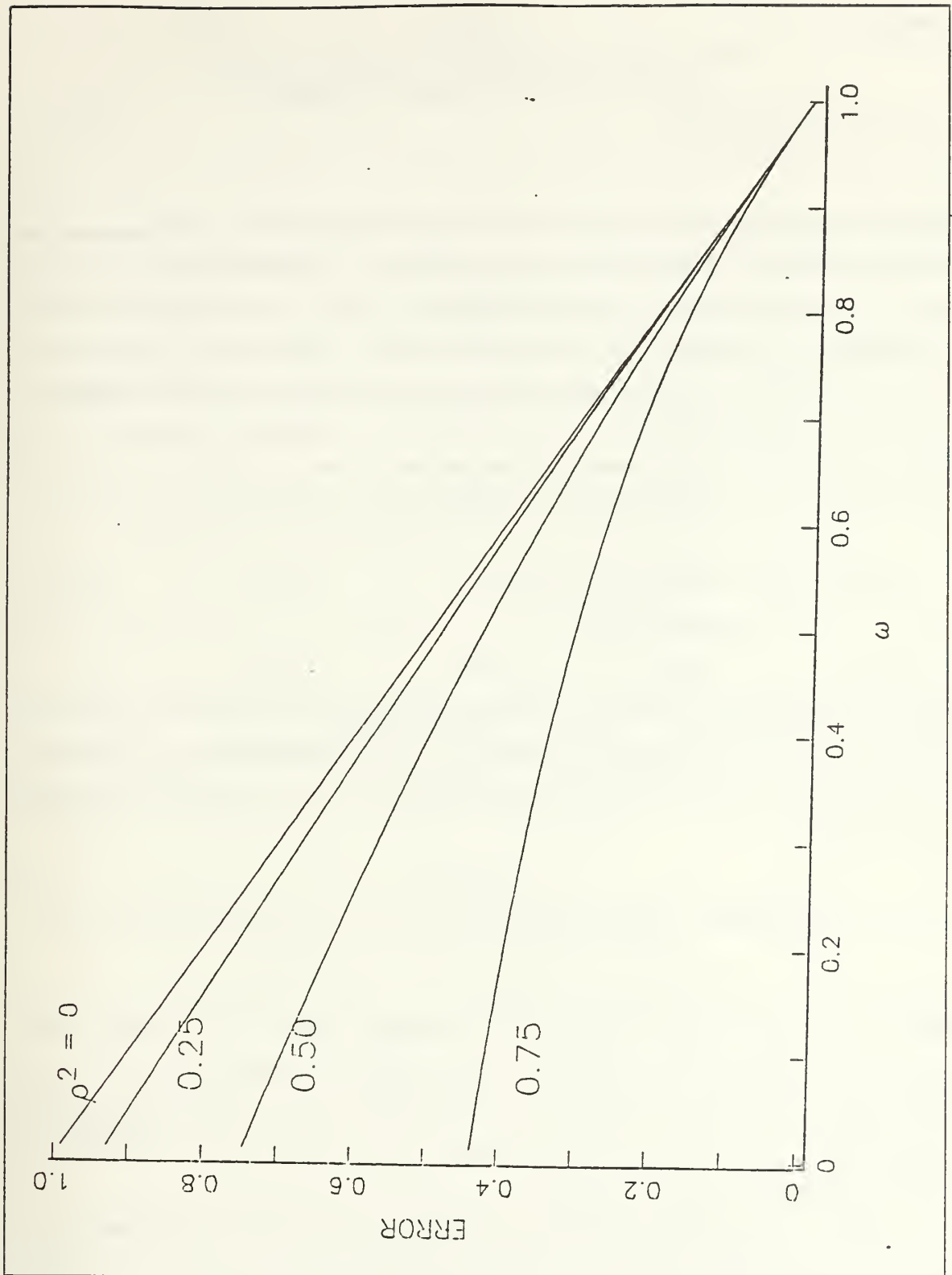

Figure 6.2 Relative Mean Square Estimation Error vs. ω .

Therefore

$$\omega \leq \frac{1}{\sigma_1^2} \sum_{k=1}^N P_k Q_k^2 \quad (6.16)$$

gives an upper bound of ω . Equation (6.15) says we maximize ω , and thus minimize $E\{e^2\}$ by making the quantization level Q_k equal to the conditional mean of y_1 given that y_1 lies in the k th quantization interval. This is one of the conditions characterizing the classical Lloyd-Max quantizer [18,23.] There remains the problem of how to pick $X_k, k=1,2,\dots,N$, so that the upper bound of ω in (6.16) is maximum. Notice that the upper bound of ω is η . Therefore, the optimum quantizer will be a Lloyd-Max quantizer if we prove that maximizing η over all choices of the set of points $\{X_k\}, k=1,2,\dots,N$, is equivalent to minimizing the distortion $E\{(y_1-y_{1q})^2\}$. Since

$$\begin{aligned} E\{(y_1-y_{1q})^2\} &= \sigma_1^2 - 2\sigma_1^2\eta + \sigma_1^2\eta \\ &= \sigma_1^2(1-\eta) \end{aligned} \quad (6.17)$$

then maximizing η will minimize the distortion $E\{(y_1-y_{1q})^2\}$ and vice versa. Since the Lloyd-Max quantizer is the optimum quantizer for minimum distortion it follows that it is also optimum for our problem. Accordingly choose X_k 's such that [23,18], (see also Appendix G)

$$X_k = \frac{Q_k + Q_{k-1}}{2}, k=1,2,\dots,N. \quad (6.18)$$

Equations (6.15) and (6.18) along with (6.7) completely design the quantizer [23,18]. Parameters of the Lloyd-Max quantizer can be calculated efficiently using the method of successive substitution (Appendix G). Values of $E\{e^2\}/\sigma_1^2$ vs. N are listed in Table 2 for $\rho = 0, 0.25, 0.5, 0.75$. The table shows the exponential decay of the MMSE as the number of quantization levels increases.

Table 3 shows a comparison between the average number of bits per sample used in this system and another method in which the Maximum Output Entropy (MOE) Quantizer [36] is used. Huffman coding [37] is assumed for both quantizers.

TABLE 2
 MINIMUM MEAN SQUARE ERROR VS. THE
 NUMBER OF QUANTIZATION LEVELS

N	ρ	0	0.25	0.5	0.75
2		0.3634	0.3548	0.3241	0.2477
4		0.1175	0.1166	0.1131	0.1021
8		0.0345	0.0345	0.0342	0.0330
16		0.0095	0.0095	0.0095	0.0094
32		0.0025	0.0025	0.0025	0.0025
64		0.0006	0.0006	0.0006	0.0006
128		0.00016	0.00016	0.00016	0.00016

TABLE 3
 COMPARISON OF THE AVERAGE NUMBER OF BITS IN
 THE MMSE AND THE MOE SYSTEMS

N	2	4	6	8
Optimum System	1	1.989	2.4768	2.8842
MOE	1	2	2.667	3

C. CONCLUSION

The trade off between performance and communication is clear from Table 2. For $\rho = 0.5$ the relative MMSE is 0.75 without communication. This corresponds to substituting $\omega = 0$ in (6.11). The relative MMSE decreases to 0.32 using one information bit per sample. The relative MMSE is 0.11 using two bits/sample. It is only 0.03 using 3 information bits/sample ($N=8$) and is 0.00016 using 7 bits/sample. We also notice that for high number of quantization levels the estimation error is approximately equal to the the quantization error. This means that the estimator depends mainly on y_{1q} for fine quantization. For coarser quantization the estimator depends heavily on y_2 to reduce the MMSE. Table 3 shows that the designed system has considerable reduction in the number of bits per sample compared to the MOE quantizer system.

D. GENERALIZATION TO THE VECTOR CASE

In this section we will consider regeneration of a random vector \underline{y}_1 from its quantized version \underline{y}_{1q} and a correlated continuous scalar y_2 . As an application consider a sensor S_2 monitoring the activities of N stations. Due to some considerations, perhaps of safety nature, only simple sensors can be placed near the stations. Because of other considerations, such as limited bandwidth communication channels, only quantized sensor measurements can be sent to the monitor. Specific examples can be the case of monitoring the states of a target in a far field or the positions of N targets in a multitasking problem [38,39]. Another example is to monitor the radiation levels outside of N nuclear reactors. A third example is monitoring the activities of N enemy transmitters.

Let us design the quantizers at the N sensor sites and the estimation rule at the monitor site so as to minimize the mean square error of each component of \underline{y} . Let \underline{y}_1 , the sensor observation vector be given by;

$$\underline{y}_1 = [y_{11} \ y_{12} \ \dots \ y_{1N}]^t, \quad (6.19)$$

where y_{1j} is the j_{th} sensor observation, $j=1,2,\dots,N$. We will assume that components of \underline{y} are independent. i.e.

$$f(y_{1i} / y_{1j}, y_2) = f(y_i / y_2) \quad , i \neq j, i,j = 1,2,\dots,N. \quad (6.20)$$

Under the above conditions, also y_{1i} and y_{1jq} are conditionally independent for $i \neq j$, so

$$f(y_{li} / \underline{y}_{1q}, y_2) = f(y_{li} / y_{1iq}, y_2), i = 1, 2, \dots, N. \quad (6.21)$$

The MMS estimate of \underline{y}_1 given \underline{y}_{1q} is given by

$$\hat{\underline{y}}_1 = E \{ \underline{y}_1 / \underline{y}_{1q}, y_2 \}. \quad (6.22)$$

Or

$$\hat{\underline{y}}_1 = \begin{bmatrix} E\{y_{11} / y_{11q}, y_2\} \\ E\{y_{12} / y_{12q}, y_2\} \\ \vdots \\ E\{y_{1N} / y_{1Nq}, y_2\} \end{bmatrix}. \quad (6.23)$$

Let us denote the error vector by \underline{E} , so

$$\underline{E} = [e_1 \ e_2 \ \dots \ e_N]^t \quad (6.24)$$

where e_i is the error in estimating y_i , $i = 1, 2, \dots, N$. The MMS error covariance matrix is

$$E\{ \underline{E} \underline{E}^t \} = E\{ (\underline{y}_1 - \hat{\underline{y}}_1)(\underline{y}_1 - \hat{\underline{y}}_1)^t \}. \quad (6.25)$$

The trace of the error covariance matrix is given by

$$\text{trace}(E\{ \underline{E} \underline{E}^t \}) = \sum_{i=1}^N E\{e_i^2\} \quad (6.26)$$

where

$$e_i = y_i - E\{y_{li} / y_{1iq}, y_2\}. \quad (6.27)$$

Minimizing the trace of the covariance matrix in (6.26) is accomplished by minimizing each summand alone since every summand is nonnegative. Now assuming Linear Minimum Mean Square Estimation, the problem of minimizing $E\{e_i^2\}$ implies using the Lloyd-Max Quantizer to quantize y_{li} as was shown previously.

In conclusion the Linear Minimum Mean Square Estimate of the observation vector \underline{Y} implies using the Lloyd-Max quantizers at the sensor sites and the same linear combining considered in the scalar case at the central processor.

VII. SUMMARY, RESULTS, CONCLUSIONS AND SUGGESTIONS FOR FUTURE RESEARCHS

A. SUMMARY

This Thesis begins by listing some reasons why Distributed Signal Processing is more practical than Centralized Signal Processing. The status of Distributed Detection, an important case of Distributed Signal Processing, and its complexity are reviewed in Chapter I.

Chapter II deals with the problem of optimum fusion of local decisions into a global decision. The relationship between the optimum fusion rule and the ratio of error cost is shown. The dependance of the performance of the optimum fusion rule on the correlation coefficients between sensor observations is thoroughly analyzed. For higher values of the correlation coefficients the Distributed Detection system is shown to reduce to the detector of the highest signal-to-noise ratio.

A compromise technique between Centralized Detection and Distributed Detection, Quantized Detection, is suggested in Chapter III. The main issue of that chapter is to control the degree of centralization according to the communications channel constraints. The Quantized Detection technique replaces local detectors by quantizers and sets a global fusion rule that approximates the centralized decision rule. The algorithm matches the other techniques at extreme limits.

Chapter IV contains some specific applications of the Quantized Detection Algorithm for detection problems. A significant performance improvement is attained by replacing Distributed Detection with Quantized Detection with three quantization levels (one and half information bits per sample vice one information bit per sample).

Chapter V considers applicability of the Quantized Detection Algorithm to the case of vector observations. In this case local sufficient statistics are quantized in the same way as before.

Chapter VI deals with the regeneration of sensor observations from their quantized versions and another correlated observation. The local quantizers and the optimum linear data fusion are designed. We arrive at the following results and conclusions.

B. RESULTS

1. Detection with Distributed Sensors

a. Optimum Fusion Rules in Distributed Detection

The optimum fusion rule depends on the ratio of costs of different types of detection errors. For high cost of false alarm relative to the cost of missing the target the AND fusion rule is better than the OR fusion rule, and vice versa.

The performance of the optimum fusion rule depends on the degree of correlation between sensors. The performance degrades as the correlation coefficient increases. The worst performance of the optimum fusion rule is at and above a critical value of the correlation coefficient ρ_{cr} . In that region of correlation the best system employs only the detector of higher signal-to-noise ratio, ignoring the lower signal-to-noise ratio sensor entirely. The performance of the Distributed Detection system improves as the signal-to-noise ratio imbalance between sensors increases. However there is a large performance difference between the Centralized Detection and the Distributed Detection for values of the correlation coefficient above ρ_{cr} .

Below ρ_{cr} the performance of the Distributed Detection system improves as the correlation coefficient gets smaller. The best performance (lowest detection cost) of the Distributed Detection system is achieved at $\rho = -1$. Recall that the Centralized Detection system has perfect detection at $\rho = -1$. This is due to the efficient use of the information contained in two observations of positive signals and anticorrelated noise samples.

The large performance difference between Centralized Detection and Distributed Detection systems is due to the loss of information in the local detection processes. As a remedy to the performance degradation in Distributed Detection we have introduced the Quantized Detection Algorithm.

b. Quantized Detection

There is a great improvement in the system performance using Quantized Detection with three quantization levels in comparison to Distributed Detection. This performance difference between Quantized Detection and Distributed Detection decreases as the correlation between sensors increases.

The Quantized Detection algorithm is applicable to the case of vector observations and waveform observations. In those cases, the local sufficient statistics are to be quantized at the local processor and transmitted to the central site for fusion.

The Quantized Detection algorithm is implemented by the quantizers as local processors and a fusion rule, suggested by the Centralized Detection decision rule, at the central site. The quantizers used in the Quantized Detection algorithm are designed to minimize the detection cost.

2. Minimum Mean Square Estimation in Distributed Sensor Systems

Minimum mean square estimation in Distributed Sensor Systems involves the classical Lloyd-Max minimum distortion quantizers at the local levels and linear processing at the global central level. A faster iterative algorithm to calculate the Lloyd-Max quantizer parameters is the method of successive substitution. It also has more accurate results than previously reported techniques.

C. CONCLUSIONS

We conclude the following:

1. Global optimization of the Distributed Detection implies picking the fusion rule and corresponding local decisions that minimizes the detection cost.
2. The optimum fusion rule in Decentralized Detection depends on the correlation coefficient, the a priori probabilities and the ratio of costs.
3. For optimum fusion of two local unbalanced decisions there is a particular value of ρ that decides the optimum fusion rule.
4. For $\rho \leq \rho_{cr}$ OR fusion is better for higher cost of missing target while AND fusion is better for higher costs of false alarm.
5. For $\rho > \rho_{cr}$ the optimum fusion rule is to ignore the sensor of lower signal-to-noise ratio and optimize the decision of the higher signal-to-noise ratio sensor.
6. The poor performance of Distributed Detection compared to Centralized Detection is due to the loss of information at the local levels.
7. The Quantized Detection system matches the Distributed Detection system and the Centralized Detection system for the two extreme conditions of quantization. As the number of quantization levels increases the Quantized Detection converges to Centralized Detection.
8. The Quantized Detection algorithm has a tremendous improvement in performance over Distributed Detection even with only 3 quantization levels.
9. The performance difference between Quantized Detection and Distributed Detection increases as the correlation of the observations gets smaller.
10. In case of linear Centralized Detection threshold equations in the observation space, Distributed Detection and Centralized Detection are special cases of Quantized Detection.
11. The Quantized Detection algorithm can get the maximum allowable performance in the presence of communication constraints.

12. The Quantized Detection algorithm can be applied to arbitrary distributions for the observations.
13. The method of successive substitution is applicable to the design of many types of quantizers. It has a simple programming procedure and very accurate results.

D. SUGGESTIONS FOR FUTURE RESEARCH

The following are some areas the Quantized Detection algorithm can extend to:

1. Optimum detection using quantized sensor observations for the case of unknown signal in noise.
2. Detection of M-ary phenomena using quantized sensor data.
3. Utilizing the Quantized Detection algorithm over noisy channels.
4. Illustration of the relation between the complexity in some suitable units and the amount of information delivered to the fusion center.
5. Utilizing the Quantized Detection algorithm to meet the Neyman-Pearson criterion.
6. Extension of Distributed Detection and Quantized Detection to more than two sensors with correlated observations and unequal SNR's.
7. Development of general principles for parsing fusion rules given a Centralized Detection surface in N-dimensional space.
8. Application of the Quantized Detection method to target detection, classification and tracking using distributed sensors.

APPENDIX A
PROBABILITY OF DETECTION AND PROBABILITY OF FALSE
ALARM OF THE PRIMARY DECISION MAKER

Given that the Primary Decision Maker (PDM) receives Q_j (the j_{th} quantization level of the Consultant observation y_1), and that its own observation is y_2 , its observation space is divided into two decision subspaces Z_{1j} and Z_{0j} . Let us denote the conditional probability of detection and probability of false alarm given Q_j by P_{dj} and P_{fj} respectively. P_{dj} and P_{fj} are given by:

$$P_{dj} = \Pr(\text{Declare } H_1 / y_{1q} = Q_j, H_1 \text{ is true}) \quad (\text{A.1})$$

and

$$P_{fj} = \Pr(\text{Declare } H_1 / y_{1q} = Q_j, H_0 \text{ is true}). \quad (\text{A.2})$$

These can be expressed as:

$$P_{dj} = \int_{y_2 \in Z_{1j}} f(y_2 / y_{1q} = Q_j, H_1) dy_2 \quad (\text{A.3})$$

and

$$P_{fj} = \int_{y_2 \in Z_{1j}} f(y_2 / y_{1q} = Q_j, H_0) dy_2 \quad (\text{A.4})$$

or equivalently as ,

$$P_{dj} = \int_{y_2 \in Z_{1j}} \int_{y_1} f(y_1, y_2 / y_{1q} = Q_j, H_1) dy_1 dy_2 \quad (\text{A.5})$$

and

$$P_{fj} = \int_{y_2 \in Z_{1j}} \int_{y_1} f(y_1, y_2 / y_{1q} = Q_j, H_0) dy_1 dy_2 \quad (\text{A.6})$$

But $f(y_1, y_2 / Q_j, H_i)$ is given by [40]

$$f(y_1, y_2 / Q_j, H_i) = \begin{cases} f(y_1, y_2 / H_i) / \Pr(Q_j / H_i) & , y_1 \in [X_j, X_{j+1}] \\ 0 & \text{otherwise} \end{cases} \quad (\text{A.7})$$

where $\Pr(Q_j / H_i)$ is the probability of the j_{th} quantization level of y_1 under hypothesis H_i . It is given by:

$$\Pr(Q_j / H_i) = \int_{X_j}^{X_{j+1}} f(y_1 / H_i) dy_1, \quad j = 1, 2, \dots, N, \quad i = 0, 1 \quad (\text{A.8})$$

The probability of detection and probability of false alarm are now

$$P_d = \sum_{j=1}^N \Pr(Q_j / H_1) P_{dj} \quad (\text{A.9})$$

and

$$P_f = \sum_{j=1}^N \Pr(Q_j / H_0) P_{fj} \quad (\text{A.10})$$

Inserting (A.5) and (A.6) into (A.9) and (A.10) yields

$$P_d = \sum_{i=1}^N \int_{X_i}^{X_{i+1}} \int_{y_2 \in Z_{1j}}^{\infty} f(y_1, y_2 / H_1) dy_1 dy_2 \quad (\text{3.4})$$

and

$$P_f = \sum_{i=1}^N \int_{X_i}^{X_{i+1}} \int_{y_2 \in Z_{1j}}^{\infty} f(y_1, y_2 / H_0) dy_1 dy_2 \quad (\text{3.5})$$

where Z_{1j} is the decision region Z_1 given that $y_1 \in [X_j, X_{j+1}]$.

APPENDIX B

PROGRAM LISTING TO CALCULATE PARAMETERS OF THE N AND THE (N + 1)-LEVEL QUANTIZERS

In this appendix we give a program listing to calculate the parameters of the N and the (N + 1)-level quantizers in configuration A

```

C*****
C THIS PROGRAM CALCULATES THE OPTIMUM N-LEVEL AND (N+1)-level
C QUANTIZER PARAMETERS
C FOR A SYSTEM OF TWO QUANTIZERS AND THEIR FUSION CENTER.
C THE RATIO OF COSTS C RANGES FROM 0.1 AND 10 .
C THE VALUE OF N =2,3,4,5 AND 6.
C THE PROGRAM USES THE MODIFIED METHOD OF SUCCESSIVE SUBSTITUTIONS .
C*****
C
      REAL*8 X(9),T(9),XX(9),TT(9),C,S1,S2,A,B,A12,A21,R,C1(20),R1(2)
      1,AERR,RERR,ERROR,PD,PF,PD1(20,9,6),PF1(20,9,6),PD2
      1,PF2,PDC,PFC,X2,R3(20,2,6),X11,DCADER,F1,F2,APD,APF,A1,A2,AP
      INTEGER K,N,I,P,N1,N2,M,J,MX
      EXTERNAL F1,F2
      COMMON X11,R
      DATA C1/10.000,9.000,8.000,7.000,6.000,5.000,4.000,3.000,2.000,
      11.5000,
      11.000,.9000,.8000,.7000,.6000,.5000,.4000,.3000,.2000,0.1000/
      A1=1.000
      A2=2.000
      S1=1.000
      S2=1.000
      R1(1)=0.60000
      R1(2)=0.80000
      AERR=0.000
      RERR=0.0001000
C*****
C INITIAL GUESS
      XX(1)=-9.500000D0
      XX(2)=-1.900000D0
      XX(3)=-1.500000D0
      XX(4)=-0.890000D0
      XX(5)=00.500000D0
      XX(6)=0.090000D0
      XX(7)=00.990000D0
      XX(8)=01.500000D0
      XX(9)=2.090000D0
C
      TT(1)=4.670000D0
      TT(2)=3.890000D0
      TT(3)=2.670000D0
      TT(4)=2.290000D0
      TT(5)=1.900000D0
      TT(6)=1.490000D0
      TT(7)=1.090000D0
      TT(8)=00.500000D0
      TT(9)=0.190000D0
C*****
C THE FOLLOWING INITIAL VALUES OF T'S CORRESPOND TO THE CASE
C OF CORRELATION COEFFICIENT GREATER THAN A1/A2
      TT(9)=4.670000D0
      TT(8)=3.890000D0
      TT(7)=2.670000D0
      TT(6)=2.290000D0
      TT(5)=1.900000D0
      TT(4)=1.490000D0
      TT(3)=1.090000D0

```



```

TT(2)=00.50000D0
TT(1)=0.19000D0
DO 500 N=2,2
  WRITE(9,60)N
  DO 600 I=6,9
C*****
C INPUT VALUE(S) OF THR CORRELATION COEFFICIENTS
  R=0.10D0*DFLOAT(I)
  WRITE(9,61)R
C DO 200 M=1,20
  M=1
  C=C1(M)
  WRITE(9,61)C
C*****
C INPUT MAXIMUM NUMBER OF ITERATIONS HERE
  MX=250
  K=0
5 K=K+1
  IF (K .GT. MX) GO TO 10
  IF (K .GT. 1) X(N)=XX(N)
  IF (K .GT. 1) T(N)=TT(N)
  IF (K .GT. 1) X(N)=XX(N)
  IF (K .GT. 1) T(N)=TT(N)
  A=(S1*XX(2)-R*S2*TT(1))/((S1*S2*DSQRT((1.0D0-R**2)*2.0D0))
  A12=(S2*A1-R*S1*A2)/((S1*S2*DSQRT((1.0D0-R**2)*2.0D0))
  A21=(S1*A2-R*S2*A1)/((S1*S2*DSQRT((1.0D0-R**2)*2.0D0))
  TT(1)=(A2*A2/2.0D0+DLOG(C)+DLOG((DERFC(A)-
1 2.0D0)/(DERFC(A-A12)-2.0D0)))/A2
  T(1)=TT(1)
  A=(S1*TT(2)-R*S2*XX(2))/((S1*S2*DSQRT((1.0D0-R**2)*2.0D0))
  B=(S2*T(1)-R*S1*XX(2))/((S2*S1*DSQRT((1.0D0-R**2)*2.0D0))
  XX(2)=(A1*A1/2.0D0+DLOG(C)+DLOG((DERFC(A)-
1 DERFC(B))/(DERFC(A-A21)-DERFC(B-A21))))/A1
  X(2)=XX(2)
  IF (N .EQ. 2) GO TO 17
  DO 15 P=2,N-1
    X(P)=XX(P)
    A=(S1*X(P)-R*S2*T(P))/((S1*S2*DSQRT((1.0D0-R**2)*2.0D0))
    B=(S2*X(P+1)-R*S1*T(P))/((S2*S1*DSQRT((1.0D0-R**2)*2.0D0))
    TT(P)=(A2*A2/2.0D0+DLOG(C)+DLOG((DERFC(A)-
1 DERFC(B))/(DERFC(A-A12)-DERFC(B-A12))))/A2
    T(P)=TT(P)
    A=(S1*T(P+1)-R*S2*X(P+1))/((S1*S2*DSQRT((1.0D0-R**2)*2.0D0))
    B=(S2*T(P)-R*S1*X(P+1))/((S2*S1*DSQRT((1.0D0-R**2)*2.0D0))
    XX(P+1)=(A1*A1/2.0D0+DLOG(C)+DLOG((DERFC(A)-
1 DERFC(B))/(DERFC(A-A21)-DERFC(B-A21))))/A1
15 CONTINUE
17 CONTINUE
  TT(N)=(A2*A2/2.0D0+DLOG(C)+DLOG(DERFC((XX(N)-R*TT(N))/
1DSQRT((1.0D0-R**2)*2.0D0))
  1/DERFC((XX(N)-A1-R*(TT(N)-A2)))/
1DSQRT((1.0D0-R**2)*2.0D0))
  1)/A2
C*****
C CHECKING THE ACCURACY
C INPUT REQUIRED PRECISION HERE
  AP=0.10d-07
  IF((DABS(T(N)-TT(N)) .GT. AP).OR.(DABS(X(N)-XX(N)) .GT.
1 AP))GO TO 5
10 CONTINUE
  X(1)=-10.0D0
  X(N+1)=10.0D0
  APD=0.0D0
  APF=0.0D0
  DO 81 Q=1,N
    A=X(Q)
    B=X(Q+1)
    X11=T(Q)
    APD=APD+0.50D0*DCADRE(F1,A,B,AERR,RERR,ERROR,IRE1)

```

```

      IF (IRE1 .NE. 0) WRITE(6,60)IRE1
      APF=APF+0.5000*DCADRE(F2,A,B,AEERR,RERR,ERROR,IRE1)
      IF (IRE1 .NE. 0) WRITE(6,60)IRE1
81  CONTINUE
      PD1(M,I,N)=APD
      PF1(M,I,N)=APF
      R3(M,I,N)=1.000+C1(M)*APF-APD
C*****
C  QUANTIZER PARAMETERS
      DO 120 J=1,N
        WRITE(9,62) X(J),T(J)
120  CONTINUE
C  WRITE(9,90)
C200 CONTINUE
C  WRITE(9,90)
C  WRITE(9,90)
C 600 CONTINUE
C  WRITE(9,90)
C  WRITE(9,90)
C  WRITE(9,90)
C 500 CONTINUE
      DO 501 J=1,2
        DO 502 I=1,20
C*****
C  OUTPUT DETECTION COST
      WRITE(10,61)C1(I),( R3(I,J,N) ,N=2,6)
C*****
C  OUTPUT PROBABILITY OF DETECTION AND PROBABILITY OF
C  FALSE ALARM FOR DIFFERENT VALUES OF N
      WRITE(8,61)( PD1(I,J,N),PF1(I,J,N) ,N=2,6)
502  CONTINUE
501  CONTINUE
60  FORMAT(1X,I4,4(1X,F15.8))
C90  FORMAT(2X,'CON A *****')
61  FORMAT(1X,10(1X,F6.4))
62  FORMAT(1X,2(1X,F15.8))
      STOP
      END
      FUNCTION F1(X)
      REAL*8 X,F1,A1,A2,R,X11,F11,F12
      COMMON X11,R
      A1=1.000
      A2=2.000
      F11=DEXP(-(X-A1)**2/2.000)/
1DSQRT(8.000*DATAN(1.000))
      F12=DERFC((X11-A2-(X-A1)*R)/
1(DSQRT(2.000*(1.000-R**2))))
      F1=F11*F12
      RETURN
      END
      FUNCTION F2(X)
      REAL*8 X,F2,R,X11,F11,F12
      COMMON X11,R
      F11=DEXP(-X**2/2.000)/
1DSQRT(8.000*DATAN(1.000))
      F12=DERFC((X11-X*R)/
1DSQRT(2.000*(1.000-R**2)))
      F2=F11*F12
      RETURN
      END

```

APPENDIX C

PROGRAM LISTING TO CALCULATE PARAMETERS OF THE TWO QUANTIZERS

In this appendix we give a program listing to calculate the parameters of the two N-level quantizers in Configuration B.

```

C*****
C THIS PROGRAM CALCULATES THE OPTIMUM N-LEVEL QUANTIZER PARAMETERS
C FOR A SYSTEM OF TWO QUANTIZERS AND THEIR FUSION CENTER .
C THE CORRELATION COEFFICIENT IS ASSUMED TO BE LESS THAN A1/A2.
C FOR THE CORRELATION COEFFICIENT IS GREATER THAN A1/A2 THE
C THE PROGRAM NEEDS SLITE MODIFICATIONS ACCORDING TO THE QD ALGORITHM.
C THE RATIO OF COSTS C RANGES FROM 0.1 AND 10.
C THE VALUE OF N =2,3,4,5 AND 6.
C THE PROGRAM USES THE MODIFIED METHOD OF SUCCESSIVE SUBSTITUTIONS .
C*****
      REAL*8 X(8),T(8),XX(8),TT(8),A1,A2,S1,S2,R,T12,T21,AA2,A,B
      1,AEERR,RERR,ERROR,PD,PF,PD1(20,9,6),PF1(20,9,6),PD2
      1,PF2,PDC,PFC,C1(20),A21,A12,C,X2
      1,X11,DCADER,F1,F2,APD,APF,R3(20,2,6)
      INTEGER K,N,I,IER1,IER2,M,P,Q,L
      EXTERNAL F1,F2
      DATA C1/10.000,9.000,8.000,7.000,6.000,5.000,4.000,3.000,2.000,
      11.5000,
      11.000,.9000,.8000,.7000,.6000,.5000,.4000,.3000,.2000,0.1000/
      COMMON X11,R
C*****
C INPIT SIGNALS HERE
      A1=4.000
      A2=2.000
C INPIT VARIANCE HERE
      S1=1.000
      S2=1.000
C*****
C INITIAL GUESS OF THE PARAMETERS
      XX(1)=-0.500000D0
      XX(2)=0.890000D0
      XX(3)=01.500000D0
      XX(4)=2.890000D0
      XX(5)=03.500000D0
      XX(6)=4.090000D0
C*****
C INITIAL VALUES OF T'S FOR CORRELATION COEFFICIENT GREATER THAN A1/A2
      TT(1)=-0.670000D0
      TT(2)=0.890000D0
      TT(3)=01.670000D0
      TT(4)=2.890000D0
      TT(5)=03.500000D0
      TT(6)=4.890000D0
C*****
C INITIAL VALUES OF T'S FOR CORRELATION COEFFICIENT LESS THAN A1/A2
C PUT TT(1) > TT(2)>.....>TT(N)
C*****
      AEERR=0.000
      RERR=0.000100D0
      DO 500 N=1,5
      DO 11 I=1,2
      R=DFLOAT(I-1)*0.2500D0
      DO 20 M=1,20
      C=C1(M)
      K=0
5      K=K+1

```

```

C      WRITE(6,60)K,T1,T11,T2,T22
      IF (K .GT.100) GO TO 10
      DO 25 L=1,N
      T(L)=TT(L)
      X(L)=XX(L)
25     CONTINUE
      XX(1)=(A1*A1/2.0D0+DLOG(C)+DLOG(DERFC((T(1)-R*X(1))/
1DSORT((1.0D0-R**2)*2.0D0))
1/DERFC((T(1)-A2-R*(X(1)-A1))/
1DSORT((1.0D0-R**2)*2.0D0))
1))/A1
      IF (N .EQ. 1) GO TO 16
      A21=(S1*A2-R*S2*A1)/(S1*S2*DSORT((1.0D0-R**2)*2.0D0))
      A12=(S2*A1-R*S1*A2)/(S1*S2*DSORT((1.0D0-R**2)*2.0D0))
      DO 15 P=1,N-1
      A=(S1*X(P)-R*S2*T(P))/(S1*S2*DSORT((1.0D0-R**2)*2.0D0))
      B=(S2*X(P+1)-R*S1*T(P))/(S2*S1*DSORT((1.0D0-R**2)*2.0D0))
      TT(P)=(A2*A2/2.0D0+DLOG(C)+DLOG((DERFC(A)-
1 DERFC(B))/(DERFC(A-A12)-DERFC(B-A12))))/A2
      A=(S1*T(P+1)-R*S2*X(P+1))/(S1*S2*DSORT((1.0D0-R**2)*2.0D0))
      B=(S2*T(P)-R*S1*X(P+1))/(S2*S1*DSORT((1.0D0-R**2)*2.0D0))
      XX(P+1)=(A1*A1/2.0D0+DLOG(C)+DLOG((DERFC(A)-
1 DERFC(B))/(DERFC(A-A21)-DERFC(B-A21))))/A1
15    CONTINUE
16    CONTINUE
      TT(N)=(A2*A2/2.0D0+DLOG(C)+DLOG(DERFC((X(N)-R*T(N))/
1DSORT((1.0D0-R**2)*2.0D0))
1/DERFC((X(N)-A1-R*(T(N)-A2))/
1DSORT((1.0D0-R**2)*2.0D0))
1))/A2
      IF((DABS(T(N)-TT(N)) .GT. 0.10D-05).OR.(DABS(X(N)-XX(N)) .GT.
1 0.10D-05))GO TO 5
10    CONTINUE
      X(N+1)=10.0D0
      APD=0.0D0
      APF=0.0D0
      DO 81 Q=1,N
      A=X(Q)
      B=X(Q+1)
      X11=T(Q)
      APD=APD+0.50D0*DCADRE(F1,A,B,AEERR,RERR,ERROR,IRE1)
      IF (IRE1 .NE. 0) WRITE(6,60)IRE1
      APF=APF+0.50D0*DCADRE(F2,A,B,AEERR,RERR,ERROR,IRE1)
      IF (IRE1 .NE. 0) WRITE(6,60)IRE1
81    CONTINUE
      PD1(M,I,N)=APD
      PF1(M,I,N)=APF
      R3(M,I,N)=1.0D0+C1(M)*PF1(M,I,N)-PD1(M,I,N)
C*****
C OUTPUT SYSTEM PARAMETERS
      DO 120 J=1,N
      WRITE(9,62) X(J),T(J)
120   CONTINUE
C      WRITE(9,61)C,T(1),T(2),APD,APF
C      WRITE(8,61)APD,APF
C      WRITE(6,61)C,X(1),X(2),APD,APF,PDC,PFC
20    CONTINUE
11    CONTINUE
C      WRITE(9,90)
      WRITE(8,90)
500   CONTINUE
C*****
C OUTPUT AVERAGE COST
      DO 501 J=1,2
      DO 502 I=1,20
      WRITE(10,61)C1(I),( R3(I,J,N) ,N=1,5)
C*****
C OUTPUT PROB. OF DETECTION AND PROB. OF FALSE ALARM
      WRITE(8,61)( PD1(I,J,N),PF1(I,J,N) ,N=1,5)
502   CONTINUE

```



```

        WRITE(8,90)
501 CONTINUE
60  FORMAT(1X,I2,9(1X,F6.4))
90  FORMAT(2X,'CON B *****')
61  FORMAT(1X,10(1X,F6.4))
62  FORMAT(1X,2(1X,F15.8))
      STOP
      END
      FUNCTION F1(X)
      REAL*8 X,F1,A1,A2,R,X11,F11,F12
      COMMON X11,R
      A1=4.000
      A2=2.000
      F11=DEXP(-(X-A1)**2/2.000)/
1DSQRT(8.000*DATAN(1.000))
      F12=DERFC((X11-A2-(X-A1)*R)/
1(DSQRT(2.000*(1.000-R**2))))
      F1=F11*F12
      RETURN
      END
      FUNCTION F2(X)
      REAL*8 X,F2,R,X11,F11,F12
      COMMON X11,R
      F11=DEXP(-X**2/2.000)/
1DSQRT(8.000*DATAN(1.000))
      F12=DERFC((X11-X*R)/
1DSQRT(2.000*(1.000-R**2)))
      F2=F11*F12
      RETURN
      END

```

APPENDIX D

PROGRAM LISTING TO CALCULATE PARAMETERS OF THE TWO QUANTIZERS FOR THE CASE OF EXPONENTIAL DISTRIBUTIONS

```

C *****
C THIS PROGRAM CALCULATES THE OPTIMUM N-LEVEL QUANTIZERS OF TWO SEN-
C SOR OBSERVATIONS OF EXPONENTIAL DISTRIBUTIONS
C TO MINIMIZE A GLOBAL SYSTEM RISK FOR FUSION
C SEE CHAPTER IV
C *****
  REAL*8 X(8),T(8),XX(8),TT(8),PD,PF,PD1(20,9,6),PF1(20,9,6),PD2
  1,PF2,PDC,PFC,C1(20),C,X2,X11,APD,APF,R3(20,2,6),AL,BL,Y
  1,APC(20,2),AFC(20,2),R4(20,2),AD2,AF2,RR2,AP
  INTEGER K,N,I,IER1,IER2,M,P,Q,L,MX
  DATA C1/50.000,40.000,30.000,20.000,15.000,10.000,9.000,
  18.000,7.000,6.000,5.000,4.000,3.000,2.000,1.5000,
  11.000,.9000,.8000,.7000,.6000/
C *****
C INITIAL VALUES OF QUANTIZER PARAMETERS
C FIRST QUANTIZER
  XX(1)=00.000000D0
  XX(2)=0.890000D0
  XX(3)=01.500000D0
  XX(4)=1.890000D0
  XX(5)=02.500000D0
  XX(6)=3.090000D0
C SECOND QUANTIZER
  TT(1)=3.090000D0
  TT(2)=2.500000D0
  TT(3)=01.890000D0
  TT(4)=1.500000D0
  TT(5)=00.890000D0
  TT(6)=0.000000D0
  DO 500 N=3,6
  DO 11 I=1,2
C PARAMETERS OF THE EXP. DISTRIBUTIONS
  AL=DFLOAT(I)*0.500D0
  DO 20 M=1,20
  C=C1(M)
  DO 55 P=1,N
    TT(P)=DLOG(2.000*C)*DFLOAT(N-P+1)/DFLOAT(N)/AL
    XX(N-P+1)=DLOG(2.000*C)*DFLOAT(N-P+1)/DFLOAT(N)/AL
55 CONTINUE
  K=0
  5 K=K+1
  DO 89 PP=1,N
    T(PP)=TT(PP)
    X(PP)=XX(PP)
89 CONTINUE
C *****
C INPUT MAXIMUM NUMBER OF ITERATIONS
  MX=200
  IF (K.GT.MX) GO TO 10
C XX(1)=DLOG(2.000*C)/AL-TT(1)
  XX(1)=0.000
  TT(1)=(DLOG(DEXP(-AL*XX(1))+DEXP(-AL*XX(2)))+DLOG(2.000*C))/AL
  DO 15 P=2,N-1
  XX(P)=(DLOG(DEXP(-AL*TT(P))+DEXP(-AL*TT(P-1)))+DLOG(2.000*C))/AL
  TT(P)=(DLOG(DEXP(-AL*XX(P))+DEXP(-AL*XX(P+1)))+DLOG(2.000*C))/AL
  15 CONTINUE
  XX(N)=(DLOG(2.000*C)+DLOG(DEXP(TT(N))+DEXP(-AL*TT(N-1))))/AL
C TT(N)=DLOG(2.000*C)/AL-XX(N)
  TT(N)=0.000
C ACCURACY CHECKING

```



```

C INPUT PRECESSION HERE
AP=0.10d-05
IF((DABS(XX(N))-X(N)) .GT. AP).OR.(DABS(TT(1)-T(1)) .GT.
1 1 AP))GO TO 5
10 CONTINUE
WRITE(8,60) K
BL=2.0D0*AL
APD=0.0D0
APF=0.0D0
DO 81 Q=1,N-1
APD=APD+DEXP(-AL*TT(Q))*{DEXP(-AL*XX(Q))-DEXP(-AL*XX(Q+1))}
APF=APF+DEXP(-BL*TT(Q))*{DEXP(-BL*XX(Q))-DEXP(-BL*XX(Q+1))}
81 CONTINUE
APD=APD+DEXP(-AL*X(N))
APF=APF+DEXP(-BL*X(N))
APC(M,I)=(1.0D0+DLOG(4.0D0*C))/(4.0D0*C)
AFC(M,I)=(1.0D0+DLOG((4.0D0*C)**2))/(4.0D0*C)**2
PD1(M,I,N)=APD
PF1(M,I,N)=APF
R3(M,I,N)=1.0D0+C1(M)*PF1(M,I,N)-PD1(M,I,N)
R4(M,I,N)=1.0D0+C1(M)*AFC(M,I)-APC(M,I)
DO 120 J=1,N
C*****
C OUTPUT QUANTIZER PARAMETERS
WRITE(9,62) XX(J),TT(J)
120 CONTINUE
WRITE(9,90)
20 CONTINUE
11 CONTINUE
WRITE(9,90)
C WRITE(9,90)
WRITE(8,90)
500 CONTINUE
DO 501 J=1,2
DO 502 I=1,20
AP2=1.0D0/(2.0D0*C1(I))
AF2=AP2**2
RR2=1.0D0+C1(I)*AF2-AP2
C*****
C OUTPUT DETECTION COST
WRITE(10,61)C1(I),RR2,( R3(I,J,N) ,N=3,6),R4(I,J)
C*****
C OUTPUT PROB. OF DETECTION AND PROB. OF FALSE ALARM
WRITE(8,61)AP2,AF2,( PD1(I,J,N),PF1(I,J,N) ,N=3,5),APC(I,J)
1,AFC(I,J)
502 CONTINUE
WRITE(8,90)
501 CONTINUE
60 FORMAT(1X,I6,9(1X,F6.4))
90 FORMAT(2X,'CON B *****')
61 FORMAT(1X,10(1X,F6.4))
62 FORMAT(1X,3(1X,F15.8))
STOP
END

```

APPENDIX E

PROGRAM LISTING TO CALCULATE PARAMETERS OF THE TWO QUANTIZERS FOR EXAMPLE 3, CHAPTER IV

```

C THIS PROGRAM CALCULATES THE OPTIMUM QUANTIZER PARAMETERS OF TWO
C N-LEVEL QUANTIZERS IN ORDER TO MINIMIZE A GLOBAL SYSTEM RISK FOR
C DETECTION OF SIGNALS WITH DIFFERENT VARIANCE. N=3 , N=5.
c S1 = SIGNAL VARIANCE UNDER H1
c S0 = SIGNAL VARIANCE UNDER H0
c T1 = QUANTIZATION POINT FOR N=3 ( T1,-T1 )
c X1,X2 QUANTIZATION POINTS FOR N=5 (X1,X2,-X1,-X2)
c C(20) ARRAY OF RATIO OF COSTS
c K = Number of iterations.
REAL*8 T1,T11,S1,S2,R,C,X2,PD,PF,C1(15),Z31,Z21,X3,X33,X22
1,TS,SSS,TTT(10),X1,PD3,PF3,PDC,PFC,R2,R3,RC
INTEGER K,N,K1
DATA C1/01.0D0,.900D0,.800D0,.700D0,0.60D0,0.50D0,0.40D0,
10.30D0,0.20D0,0.10D0,.090D0,.080D0,.070D0,0.060D0,0.050D0/
S1=1.0D0
S0=DSQRT(2.0D0)
c INITIAL VALUES OF THE QUANTIZER PARAMETERS
T1=01.15800D0
X1=01.15800D0
X2=00.15800D0
WRITE(6,60)K,S1,S0,C
WRITE(9,60)K,S1,S0,C
WRITE(8,60)K,S1,S0,C
SSS=(1.0D0/S0**2-1.0D0/S1**2)/2.0D0
DO 101 N=2,2
DO 100 I=1,15
C=C1(I)
K=0
5 K=K+1
IF (K .GT.100) GO TO 10
T11=T1
TS=(DLOG(S1/S0)+
1DLOG(C)+DLOG((DERF(T1/DSQRT(2.0D0)
1/S0))/(DERF(T1/DSQRT(2.0D0)/S1))))*DFLOAT(N-1))/SSS
C IF (TS .GT. 0.0D0) T1=DSQRT(TS)
T1=DSQRT(DSQRT(TS))
IF((DABS(T1-T11) .GT. 0.10D-05)) GO TO 5
CONTINUE
10 TTT(N)=T11
K1=0
55 K1=K1+1
IF (K1 .GT.100) GO TO 15
X33=X3
X22=X2
X2=(DLOG(S1/S0)+
1DLOG(C)+DLOG((DERF(X3/DSQRT(2.0D0)
1/S0))/(DERF(X3/DSQRT(2.0D0)/S1))))/SSS
C IF (TS .GT. 0.0D0) T1=DSQRT(TS)
X2=DSQRT(X2)
Z30=DERF(X3/DSQRT(2.0D0)/S0)
Z20=DERF(X2/DSQRT(2.0D0)/S0)
Z31=DERF(X3/DSQRT(2.0D0)/S1)
Z21=DERF(X2/DSQRT(2.0D0)/S1)
X3=(DLOG(S1/S0)+
1DLOG(C)+DLOG((Z30-Z20)/(Z31-Z21)))/SSS
X3=DSQRT(DABS(X3))
IF(((DABS(X2-X22) .GT. 0.10D-05)) .OR.(( DABS(X3-X33) .GT.
10.10D-05))) GO TO 55
CONTINUE
15 TTT(N)=T11

```

```

      TS=-DLOG(S0**2/S1**2/C)/SSS
      PDC=1.0D0-DEXP(-TS/(2.0D0*S1*S1))
      PFC=1.0D0-DEXP(-TS/(2.0D0*S0*S0))
      RC=1.0D0+C*PFC-PDC
      WRITE(9,60)K,T1,T11,X2,X22,X3,X33
      WRITE(6,60)K,T1,T11
      PD=DERF(T11/DSQRT(2.0D0)/S1)**N
      PF=DERF(T11/DSQRT(2.0D0)/S0)**N
      R2=1.0D0+C*PF-PD
      PD3=(DERF(X22/DSQRT(2.0D0)/S1)*2.0D0-
1 *DERF(X33/DSQRT(2.0D0)/S1))
      PF3=(DERF(X22/DSQRT(2.0D0)/S0)*2.0D0-
1 *DERF(X33/DSQRT(2.0D0)/S0))
      R3=1.0D0+C*PF3-PD3
      WRITE(8,60)N,PDC,PFC,PD,PF,PD3,PF3
      WRITE(10,60)N,C,R2,R3,RC
C      IF ((I.EQ. 1) .OR. (I.EQ. 10 )) WRITE(10,60)N,C,R2,R3,RC
      WRITE(6,60)N,C,TTT(N),PD,PF,PD3,PF3
100      CONTINUE
101      CONTINUE
60      FORMAT(1X,I3,6(1X,F10.7))
      STOP
      END

```

APPENDIX F
LINEAR MINIMUM MEAN SQUARE ESTIMATE OF Y_1

Having $\underline{Y} = [y_{1q} \ y_2]^t$ the LMMS estimate of y_1 and the corresponding mean square error are given by [34]:

$$\hat{y}_1 = E\{y_1 \underline{Y}^t\} E\{\underline{Y} \underline{Y}^t\}^{-1} \underline{Y} \quad (F.1)$$

and

$$E\{e^2\} = E\{y_1^2\} - E\{y_1 \underline{Y}^t\} E\{\underline{Y} \underline{Y}^t\}^{-1} E\{\underline{Y} y_1\} \quad (F.2)$$

where

$$E\{y_1 \underline{Y}^t\} = [E\{y_1 y_{1q}\} \ E\{y_1 y_2\}] \quad (F.3)$$

and

$$E\{\underline{Y} \underline{Y}^t\} = \begin{bmatrix} E\{y_{1q}^2\} & E\{y_{1q} y_2\} \\ E\{y_2 y_{1q}\} & E\{y_2^2\} \end{bmatrix} \quad (F.4)$$

The entries of these matrices are:

$$\begin{aligned} E\{y_1 y_{1q}\} &= \sum_{j=1}^N P_j Q_j E\{y_1 / y_{1q} = Q_j\} \\ &= \sum_{j=1}^N P_j Q_j C_j \\ &= \mu \sigma_1^2 \end{aligned} \quad (F.5)$$

$$E\{y_2 y_{1q}\} = \sum_{j=1}^N P_j Q_j E\{y_2 / y_{1q} = Q_j\} \quad (F.6)$$

but

$$E\{y_2 / y_{1q} = Q_j\} = E\{\{y_2 / y_1\} / y_{1q} = Q_j\} \quad (F.7)$$

For the case where y_1 and y_2 are jointly gaussian, we can write

$$E\{y_2 y_{1q}\} = \rho \sigma_1 \sigma_2 \sum_{j=1}^N P_j Q_j C_j / \sigma_1^2 \quad (F.8)$$

$$E\{y_2 y_{1q}\} = \rho \sigma_1 \sigma_2 \mu \quad (F.9)$$

$$\begin{aligned} E\{y_{1q}^2\} &= \sum_{j=1}^N P_j Q_{j2} \\ &= \sigma_1^2 \eta. \end{aligned} \quad (F.10)$$

Inserting these in (F.1) and (F.2) and performing matrix multiplications yields

$$\hat{y}_1 = \left[(1 - \rho^2) \mu y_{1q} + \rho \frac{\sigma_1}{\sigma_2} (\eta - \rho^2) y_2 \right] / (\eta - \mu^2 \rho^2) \quad (6.2)$$

and

$$E\{e^2\} = \sigma_1^2 (1 - \rho^2) (1 - \omega) / (1 - \rho^2 \omega) \quad (6.11)$$

where ω is given by:

$$\omega = \mu^2 / \eta. \quad (6.12)$$

APPENDIX G

SOLUTION OF THE LLOYD-MAX QUANTIZER PARAMETERS BY THE METHOD OF SUCCESSIVE SUBSTITUTION

1. INTRODUCTION

The minimum distortion quantizer parameters [18,23], as well as parameters based on other criterion such as quantizers for signal detection [41], minimum risk quantizers and quantizers for LMMS estimation error dealt with in this thesis, can be solved by Max's trial and error technique [18]. There are also many other approximation methods to calculate the quantizer parameters [42], [43] and [44].

In this Appendix we apply the method of successive substitution and its modifications [19] to solve for the Lloyd-Max quantizer parameters. It is more accurate and computationally more efficient than the previously reported methods. It is shown to easily generate 7 bit (128 level) optimum quantization.

2. STATEMENT OF THE PROBLEM

The Lloyd-Max minimum mean square distortion quantizer problem deals with transforming a random variable X of differentiable probability density function $f(x)$ into the N -level discrete random variable Y .

$$Y(X) = Y_i \text{ for } X \in [x_i, x_{i+1}] \quad (G.1)$$

The optimum parameters minimize the distortion D

$$D = \sum_{i=1}^N \int_{x_i}^{x_{i+1}} (x - y_i)^2 f(x) dx \quad (G.2)$$

with

$$-\infty = x_1 \leq x_2 \leq \dots \leq x_N \leq x_{N+1} = \infty$$

Differentiating D with respect to x_i and y_i yields the following necessary conditions of optimality :

$$x_i = (y_i + y_{i+1})/2, i = 2, 3, \dots, N \quad (G.3)$$

$$y_i = \left(\int_{x_i}^{x_{i+1}} x f(x) dx \right) / \left(\int_{x_i}^{x_{i+1}} f(x) dx \right), i = 1, 2, \dots, N \quad (G.4)$$

a set of simultaneous equations of propagating character. That is, if y_1 is chosen correctly then x_2 can be calculated from (G.4), y_2 from (G.3), x_3 from (G.4) and so forth [18]. In this case the value of y_N calculated from (G.3) must agree with its value calculated from (G.4) with $x_{N+1} = \infty$. This was the core of Max's trial and error algorithm; to pick a value for y_1 and calculate the parameters up to and including y_N , which must agree with the value of y_N calculated from (G.4), otherwise, to pick another value of y_1 . Let us put the system of equations in the form

$$\underline{Z} = \underline{G}(\underline{Z}) \quad (G.5)$$

where \underline{Z} is a $2N-1$ vector given by:

$$\underline{Z} = [y_1 \ x_2 \ y_2 \ \dots \ y_N]^t \quad (G.6)$$

and apply the iterative substitution

$$\underline{Z}_{\text{new}} = \underline{G}(\underline{Z}_{\text{old}}) \quad (G.7)$$

with a suitable initial guess. The convergence is guaranteed if $\partial G_k / \partial Z_j$ is sufficiently small for every $k, j = 1, 2, \dots, 2N-1$ [19]. From (G.4)

$$\partial G_j / \partial y_j = [(x_{j+1} - y_j) f(x_{j+1}) + (y_j - x_j) f(x_j)] / (2P_j) \quad (G.8)$$

where P_j is the probability the input of the quantizer is in the j_{th} interval.

$$P_j = \int_{x_j}^{x_{j+1}} f(x) dx. \quad (G.9)$$

The numerator in (G.8) is an approximation of the integral in (G.9) by the trapezoidal rule with the subdivision $[x_j, y_j, x_{j+1}]$, so the value of the derivative is very likely less than one. Also, substituting for y_j and y_{j+1} in (G.3) from (G.4) and differentiating with respect to x_j it is easily to show that

$$\partial G_j / \partial x_j = (y_j - x_j) f(x_j) / (2P_j) + (x_j - y_{j-1}) f(x_j) / 2P_{j-1} \quad (G.10)$$

which is less than $(\partial G_j / \partial y_j)$. The method can be more efficient if we use the updated values in the same iteration. In this modification of the method the best current values of the parameters are used. This choice may also enhance convergence. The method also avoids the tedious calculation of the upper limit of the integral to solve for the next x_j in (G.4).

3. NUMERICAL RESULTS

We have solved for the quantizer parameters for a gaussian random variable of zero mean and unit variance for several values of N up to 128. Also the mean square error D and the output entropy $(-\sum_k P_k \log_2 (P_k))$ have been calculated. The results presented in Table 4 show that in several cases Max's results, which were only available up to N=36, are not accurate in the last digit.

Key to Table 4

The numbering in the table is as follows.

1. For N even, each table begins with the $(N/2 + 1)_{th}$ parameters. In this case the $(N/2 + 1)_{th}$ value of x is zero.
2. For N odd, Each table begins with the $(N/2 + 2)_{th}$ parameters. In this case the $(N/2 + 2)_{th}$ value of y is zero.

Negative parameters can be calculated from the symmetry relation

$$X_j = X_{n-j+2} \quad (G.11)$$

and

$$y_j = y_{n-j+1} \quad (G.12)$$

A FORTRAN program to calculate the parameters ,distortion and entropy follows Table 4. The only input to the program is N, the number of quantization levels.

TABLE 4

MAX'S QUANTIZER PARAMETERS FOR THE NORMAL DISTRIBUTION

N = 2			N = 7		
J	X	Y	J	X	Y
2	0.000000	0.797885	4	-0.280289	0.000000
			5	0.280288	0.560577
	ERROR =	0.363380	6	0.874362	1.188147
	ENTROPY =	1.000000	7	1.610758	2.033369
=====			=====		
N = 3			ERROR = 0.044000		
J	X	Y	ENTROPY = 2.646931		
2	-0.612003	0.000000	=====		
3	0.612003	1.224006	N = 8		
			J	X	Y
	ERROR =	0.190174	5	0.000000	0.245094
	ENTROPY =	1.535789	6	0.500550	0.756005
=====			7	1.049957	1.343909
N = 4			8	1.747927	2.151946
J	X	Y	=====		
3	0.000000	0.452780	ERROR = 0.034548		
4	0.981599	1.510418	ENTROPY = 2.824865		
			=====		
	ERROR =	0.117482	N = 9		
	ENTROPY =	1.911099	J	X	Y
=====			5	-0.221819	0.000000
N = 5			6	0.221819	0.443639
J	X	Y	7	0.681217	0.918796
3	-0.382284	0.000000	8	1.197594	1.476392
4	0.382284	0.764567	9	1.865528	2.254664
5	1.244357	1.724147	=====		
			ERROR = 0.027853		
	ERROR =	0.079941	ENTROPY = 2.982695		
	ENTROPY =	2.202916	=====		
=====			N = 10		
N = 6			J	X	Y
J	X	Y	6	0.000000	0.199623
4	0.000000	0.317716	7	0.404740	0.609857
5	0.658911	1.000106	8	0.833841	1.057825
6	1.446850	1.893595	9	1.324583	1.591340
			10	1.968218	2.345096
			=====		
	ERROR =	0.057978	ERROR = 0.022937		
	ENTROPY =	2.442789	ENTROPY = 3.124584		
=====			=====		

TABLE 4

MAX'S QUANTIZER PARAMETERS FOR THE NORMAL DISTRIBUTION (CONT'D.)

N = 11			N = 14		
J	X	Y	J	X	Y
6	-0.183729	0.000000	8	0.000000	0.145706
7	0.183729	0.367458	9	0.293513	0.441321
8	0.559913	0.752367	10	0.595882	0.750443
9	0.965597	1.178826	11	0.918039	1.085635
10	1.435733	1.692639	12	1.276582	1.467528
11	2.059193	2.425746	13	1.703070	1.938612
			14	2.281837	2.625062
ERROR =		0.019220	ERROR =		0.012232
ENTROPY =		3.253506	ENTROPY =		3.582050
N = 12			N = 15		
J	X	Y	J	X	Y
7	0.000000	0.168438	8	-0.136929	0.000000
8	0.340142	0.511846	9	0.136928	0.273857
9	0.694313	0.876779	10	0.414310	0.554764
10	1.081245	1.285711	11	0.702949	0.851134
11	1.534371	1.783030	12	1.013007	1.174879
12	2.140733	2.498435	13	1.360468	1.546057
ERROR =		0.016340	14	1.776266	2.006474
ENTROPY =		3.371666	15	2.343670	2.680866
N = 13			N = 16		
J	X	Y	J	X	Y
7	-0.156887	0.000000	9	0.000000	0.128395
8	0.156887	0.313773	10	0.258222	0.388048
9	0.476012	0.638251	11	0.522404	0.656759
10	0.812600	0.986949	12	0.799550	0.942340
11	1.184106	1.381263	13	1.099286	1.256231
12	1.622890	1.864518	14	1.437139	1.618046
13	2.214522	2.564525	15	1.843532	2.069017
ERROR =		0.014063	16	2.400803	2.732590
ENTROPY =		3.480744	ERROR =		0.009501
			ENTROPY =		3.765328

TABLE 4
 MAX'S QUANTIZER PARAMETERS FOR THE NORMAL DISTRIBUTION (CONT'D.)

N = 17		N = 19	
J	X	J	X
9	0.121497	10	0.109205
10	0.121497	11	0.109204
11	0.366938	12	0.329382
12	0.620085	13	0.555076
13	0.887442	14	0.790731
14	1.178246	15	1.042234
15	1.507669	16	1.318296
16	1.905707	17	1.633568
17	2.453866	18	2.017359
	2.453866	19	2.549745
	2.453866		
	0.008467		0.006848
	0.008467		0.006848
	3.848840		4.002518
	3.848840		4.002518
N = 18		N = 20	
J	X	J	X
10	0.000000	11	0.000000
11	0.230557	12	0.208277
12	0.465324	13	0.419640
13	0.709082	14	0.637511
14	0.967981	15	0.866088
15	1.250963	16	1.110555
16	1.572915	17	1.380941
17	1.963465	18	1.690196
18	2.503372	19	2.067846
	2.503372	20	2.593337
	2.503372		
	0.114769		0.103762
	0.114769		0.103762
	3.46345		0.312791
	3.46345		0.312791
	0.584302		0.526488
	0.584302		0.526488
	0.833862		0.748533
	0.833862		0.748533
	1.102100		0.983642
	1.102100		0.983642
	1.399827		1.238467
	1.399827		1.238467
	1.746003		1.523414
	1.746003		1.523414
	2.180927		1.856977
	2.180927		1.856977
	2.825817		2.278714
	2.825817		2.278714
	2.825817		2.907961
	2.825817		2.907961
	0.007593		0.006208
	0.007593		0.006208
	3.927741		4.073583
	3.927741		4.073583

TABLE 4

MAX'S QUANTIZER PARAMETERS FOR THE NORMAL DISTRIBUTION (CONT'D.)

N = 21		N = 23	
J	X	J	Y
11	0.099179	12	0.090844
12	0.099178	13	0.090844
13	0.398856	14	0.273544
14	0.502624	15	0.459368
15	0.713667	16	0.650668
16	0.935997	17	0.850337
17	1.175138	18	1.062210
18	1.439469	19	1.291284
19	1.743269	20	1.546005
20	2.115306	21	1.840265
21	2.634448	22	2.202390
		23	2.710201
	ERROR = 0.005653		ERROR = 0.004746
	ENTROPY = 4.141290		ENTROPY = 4.267806
N = 22		N = 24	
J	X	J	Y
12	0.000000	13	0.000000
13	0.189942	14	0.174587
14	0.382215	15	0.350977
15	0.579359	16	0.531112
16	0.784380	17	0.717227
17	1.001147	18	0.912088
18	1.235056	19	1.119352
19	1.494358	20	1.344223
20	1.793180	21	1.594750
21	2.160062	22	1.884807
22	2.673330	23	2.242523
		24	2.745248
	ERROR = 0.005170		ERROR = 0.004372
	ENTROPY = 4.205942		ENTROPY = 4.327112

TABLE 4

MAX'S QUANTIZER PARAMETERS FOR THE NORMAL DISTRIBUTION (CONT'D.)

N = 25			N = 27		
J	X	Y	J	X	Y
13	-0.083805	0.000000	14	-0.077781	0.000000
14	0.083805	0.167610	15	0.077780	0.155561
15	0.252208	0.336806	16	0.233975	0.312389
16	0.423045	0.509283	17	0.392106	0.471823
17	0.598128	0.686972	18	0.553594	0.635364
18	0.779592	0.872212	19	0.720073	0.804782
19	0.970115	1.068019	20	0.893532	0.982281
20	1.173279	1.278540	21	1.076518	1.170756
21	1.394213	1.509886	22	1.272495	1.374235
22	1.640881	1.771876	23	1.486469	1.598704
23	1.927050	2.082224	24	1.726267	1.853829
24	2.280667	2.479110	25	2.005461	2.157093
25	2.778634	3.078159	26	2.351670	2.546247
			27	2.840977	3.135707
ERROR = 0.004041			ERROR = 0.003483		
ENTROPY = 4.384064			ENTROPY = 4.491610		
N = 26			N = 28		
J	X	Y	J	X	Y
14	0.000000	0.080593	15	0.000000	0.075012
15	0.161536	0.242480	16	0.150307	0.225602
16	0.324498	0.406516	17	0.301760	0.377919
17	0.490402	0.574288	18	0.455569	0.533219
18	0.660961	0.747635	19	0.613076	0.692934
19	0.838229	0.928823	20	0.775854	0.858775
20	1.024813	1.120803	21	0.945836	1.032897
21	1.224230	1.327657	22	1.125522	1.218147
22	1.441544	1.555432	23	1.318326	1.418505
23	1.684648	1.813865	24	1.529205	1.639905
24	1.967207	2.120549	25	1.765925	1.891945
25	2.316997	2.513445	26	2.041975	2.192005
26	2.810502	3.107559	27	2.384821	2.577637
			28	2.870169	3.162701
ERROR = 0.003746			ERROR = 0.003246		
ENTROPY = 4.438843			ENTROPY = 4.542507		

TABLE 4

MAX'S QUANTIZER PARAMETERS FOR THE NORMAL DISTRIBUTION (CONT'D.)

N = 29			N = 31		
J	X	Y	J	X	Y
15	-0.072566	0.000000	16	-0.068008	0.000000
16	0.072566	0.145132	17	0.068008	0.136016
17	0.218211	0.291291	18	0.204446	0.272876
18	0.365424	0.439557	19	0.342170	0.411464
19	0.515338	0.591119	20	0.482101	0.552739
20	0.669236	0.747352	21	0.625267	0.697794
21	0.828638	0.909923	22	0.772858	0.847921
22	0.995431	1.080939	23	0.926315	1.004710
23	1.172074	1.263209	24	1.087456	1.170202
24	1.361940	1.460671	25	1.258670	1.347138
25	1.569941	1.679211	26	1.443261	1.539385
26	1.803788	1.928364	27	1.646065	1.752745
27	2.076890	2.225415	28	1.874694	1.996643
28	2.416571	2.607727	29	2.142413	2.288184
29	2.898177	3.188627	30	2.476285	2.664385
			31	2.950981	3.237577
ERROR = 0.003032			ERROR = 0.002664		
ENTROPY = 4.591663			ENTROPY = 4.685201		
N = 30			N = 32		
J	X	Y	J	X	Y
16	0.000000	0.070155	17	0.000000	0.065890
17	0.140542	0.210928	18	0.131971	0.198052
18	0.282019	0.353110	19	0.264715	0.331378
19	0.425412	0.497714	20	0.399039	0.466699
20	0.571795	0.645876	21	0.535816	0.604934
21	0.722402	0.798927	22	0.676035	0.747136
22	0.878709	0.958490	23	0.820850	0.894565
23	1.042565	1.126640	24	0.971674	1.048783
24	1.216393	1.306147	25	1.130294	1.211804
25	1.403530	1.500912	26	1.299072	1.386340
26	1.608846	1.716779	27	1.481284	1.576228
27	1.840001	1.963224	28	1.681731	1.787233
28	2.110332	2.257440	29	1.907981	2.028728
29	2.447027	2.636614	30	2.173234	2.317739
30	2.925088	3.213562	31	2.504429	2.691120
			32	2.975926	3.260732
ERROR = 0.002839			ERROR = 0.002505		
ENTROPY = 4.639193			ENTROPY = 4.729784		

TABLE 4
 MAX'S QUANTIZER PARAMETERS FOR THE NORMAL DISTRIBUTION (CONT'D.)

N = 64		
J	X	Y
33	0.000000	0.033409
34	0.066844	0.100278
35	0.133787	0.167297
36	0.200932	0.234567
37	0.268380	0.302193
38	0.336238	0.370283
39	0.404616	0.438950
40	0.473632	0.508314
41	0.543408	0.578503
42	0.614079	0.649655
43	0.685789	0.721922
44	0.758695	0.795468
45	0.832972	0.870476
46	0.908816	0.947155
47	0.986446	1.025736
48	1.066112	1.106488
49	1.148104	1.189720
50	1.232757	1.275794
51	1.320468	1.365141
52	1.411709	1.458276
53	1.507054	1.555831
54	1.607210	1.658589
55	1.713065	1.767542
56	1.825759	1.883977
57	1.946794	2.009611
58	2.078211	2.146810
59	2.222896	2.298981
60	2.385143	2.471305
61	2.571789	2.672274
62	2.794840	2.917407
63	3.078922	3.240437
64	3.492269	3.744101
ERROR =		0.000644
ENTROPY =		5.710078

TABLE 4

MAX'S QUANTIZER PARAMETERS FOR THE NORMAL DISTRIBUTION (CONT'D.)

N = 128		
J	X	Y
65	-0.000001	0.01628
66	0.003333	0.05049
67	0.006667	0.08470
68	0.010000	0.08886
69	0.013333	0.11591
70	0.016667	0.14296
71	0.020000	0.15591
72	0.023333	0.16886
73	0.026667	0.18181
74	0.030000	0.19476
75	0.033333	0.20771
76	0.036667	0.22066
77	0.040000	0.23361
78	0.043333	0.24656
79	0.046667	0.25951
80	0.050000	0.27246
81	0.053333	0.28541
82	0.056667	0.29836
83	0.060000	0.31131
84	0.063333	0.32426
85	0.066667	0.33721
86	0.070000	0.35016
87	0.073333	0.36311
88	0.076667	0.37606
89	0.080000	0.38901
90	0.083333	0.40196
91	0.086667	0.41491
92	0.090000	0.42786
93	0.093333	0.44081
94	0.096667	0.45376
95	0.100000	0.46671
96	0.103333	0.47966
97	0.106667	0.49261
98	0.110000	0.50556
99	0.113333	0.51851
100	0.116667	0.53146
101	0.120000	0.54441
102	0.123333	0.55736
103	0.126667	0.57031
104	0.130000	0.58326
105	0.133333	0.59621
106	0.136667	0.60916
107	0.140000	0.62211
108	0.143333	0.63506
109	0.146667	0.64801
110	0.150000	0.66096
111	0.153333	0.67391
112	0.156667	0.68686
113	0.160000	0.69981
114	0.163333	0.71276
115	0.166667	0.72571
116	0.170000	0.73866
117	0.173333	0.75161
118	0.176667	0.76456
119	0.180000	0.77751
120	0.183333	0.79046
121	0.186667	0.80341
122	0.190000	0.81636
123	0.193333	0.82931
124	0.196667	0.84226
125	0.200000	0.85521
126	0.203333	0.86816
127	0.206667	0.88111
128	0.210000	0.89406
129	0.213333	0.90701
130	0.216667	0.92000
131	0.220000	0.93295
132	0.223333	0.94590
133	0.226667	0.95885
134	0.230000	0.97180
135	0.233333	0.98475
136	0.236667	0.99770
137	0.240000	1.01065
138	0.243333	1.02360
139	0.246667	1.03655
140	0.250000	1.04950
141	0.253333	1.06245
142	0.256667	1.07540
143	0.260000	1.08835
144	0.263333	1.10130
145	0.266667	1.11425
146	0.270000	1.12720
147	0.273333	1.14015
148	0.276667	1.15310
149	0.280000	1.16605
150	0.283333	1.17900
151	0.286667	1.19195
152	0.290000	1.20490
153	0.293333	1.21785
154	0.296667	1.23080
155	0.300000	1.24375
156	0.303333	1.25670
157	0.306667	1.26965
158	0.310000	1.28260
159	0.313333	1.29555
160	0.316667	1.30850
161	0.320000	1.32145
162	0.323333	1.33440
163	0.326667	1.34735
164	0.330000	1.36030
165	0.333333	1.37325
166	0.336667	1.38620
167	0.340000	1.39915
168	0.343333	1.41210
169	0.346667	1.42505
170	0.350000	1.43800
171	0.353333	1.45095
172	0.356667	1.46390
173	0.360000	1.47685
174	0.363333	1.48980
175	0.366667	1.50275
176	0.370000	1.51570
177	0.373333	1.52865
178	0.376667	1.54160
179	0.380000	1.55455
180	0.383333	1.56750
181	0.386667	1.58045
182	0.390000	1.59340
183	0.393333	1.60635
184	0.396667	1.61930
185	0.400000	1.63225
186	0.403333	1.64520
187	0.406667	1.65815
188	0.410000	1.67110
189	0.413333	1.68405
190	0.416667	1.69700
191	0.420000	1.70995
192	0.423333	1.72290
193	0.426667	1.73585
194	0.430000	1.74880
195	0.433333	1.76175
196	0.436667	1.77470
197	0.440000	1.78765
198	0.443333	1.80060
199	0.446667	1.81355
200	0.450000	1.82650

ERROR = 0.00163
 ENTROPY = 0.95833

4. PROGRAM LISTING TO CALCULATE THE LLOYD-MAX QUANTIZER PARAMETERS

```

C THIS PROGRAM CALCULATES LLOYD-MAX QUANTIZER PARAMETERS BY THE METHOD
C OF SUCCESSIVE SUBSTITUTION FOR THE NORMAL DISTRIBUTION OF ZERO MEAN
C AND UNIT VARIANCE
C The INPUT TO THE PROGRAM IS
C (1) THE NUMBER OF QUANTIZATION LEVELS N
C (2) THE MAXIMUM NUMBER OF ITERATIONS M
C (2) THE ACCURACY AP
C *****
C REAL*8 X(199),T(199),XX(199),TT(199),C ,DELTA,AP(199),AP
1,ERROR,ENTROP
INTEGER K,N,I,P,N1,N2,N3,M
C=DSQRT(00.50D0/DATAN(1.0D0))
C DO 99 N=110,110
C *****
C INPUT THE NUMBER OF QUANTIZATION LEVELS
N=100
WRITE(9,65)N
WRITE(9,66)
WRITE(9,67)
WRITE(9,66)
C *****
C INITIALIZATION OF THE QUANTIZER PARAMETERS
C
DELTA=0.0150D0*DFLOAT(N)
XX(1)=-10.5000D0
TT(1)=-5.5000D0
X(1)=XX(1)
T(1)=TT(1)
DO 50 L=2,N
TT(L)=TT(L-1)-DELTA
XX(L)=(TT(L)+TT(L-1))/2.0D0
X(L)=XX(L)
T(L)=TT(L)
50 CONTINUE
C *****
C BEGINING OF THE ITERATIONS
C M = MAXIMUM NUMBER OF ITERATIONS
M = 1050
K=0
5 K=K+1
IF (K .GT. M) GO TO 10
IF (K .GT. 1) X(N)=XX(N)
IF (K .GT. 1) T(N)=TT(N)
TT(1)=-C*DEXP(-XX(2)*XX(2)/2.0D0)/(DERFC(-10.0D0)-
1DERFC(XX(2)/DSQRT(2.0D0)))
T(1)=TT(1)
IF ( N .EQ. 2 ) GO TO 17
DO 15 P=2,N-1
XX(P)=(T(P)+T(P-1))/2.0D0
X(P)=XX(P)
TT(P)=DEXP(-X(P)*X(P)/2.0D0)-DEXP(-X(P+1)*X(P+1)/2.0D0)
TT(P)=TT(P)*C/(DERFC(X(P)/DSQRT(2.0D0))-DERFC(X(P+1)/DSQRT(2.0
1 D0)))
T(P)=TT(P)
15 CONTINUE
17 CONTINUE
XX(N)=(TT(N)+T(N-1))/2.0D0
TT(N)=DEXP(-XX(N)*XX(N)/2.0D0)*C/DERFC(XX(N)/DSQRT(2.0D0))
X(N)=XX(N)
T(N)=TT(N)
N2=IDINT(DFLOAT((N+2)/2))
N1=IDINT(DFLOAT((N+1)/2))
C *****
C CHECKING THE PRECISION OF THE SOLUTION
C AP = REQUIRED ACCURACY
AP=0.10D-6

```



```

IF((MOD(N,2) .EQ. 0) .AND. (DABS(X(N2)) .GT. AP)) GO TO 5
IF((MOD(N+1,2) .EQ. 0) .AND. (DABS(T(N1)) .GT. AP)) GO TO 5
CONTINUE
10 CONTINUE
C*****
C OUTPUT RESULTS
IF (MOD(N,2) .EQ. 0) N3=N2
IF (MOD(N+1,2) .EQ. 0) N3=N1
WRITE(6,60) K
DO 120 J=1,N3
  IF (J .EQ. 1)
1 WRITE(9,71) J, T(J)
  IF (J .GT. 1)
1 WRITE(9,61) J, X(J), T(J)
120 CONTINUE
X(N+1)=10.0D0
X(1)=-10.0D0
ERROR=0.0D0
ENTROP=0.0D0
DO 222 I=1,N
  AP(I)=DERFC(X(I)/DSQRT(2.0D0))-DERFC(X(I+1)/DSQRT(2.0D0))
  AP(I)=AP(I)/2.0D0
  ERROR=ERROR+AP(I)*T(I)**2
  ENTROP=ENTROP-AP(I)*DLOG(AP(I))/DLOG(2.0D0)
222 CONTINUE
ERROR=1.0D0-ERROR
WRITE(9,66)
WRITE(9,62) ERROR
WRITE(9,66)
WRITE(9,63) ENTROP
WRITE(9,66)
WRITE(6,72) K
WRITE(9,90)
WRITE(9,66)
C99 CONTINUE
65 FORMAT(3X,' N = ',I7)
66 FORMAT(3X,'-----')
67 FORMAT(3X,' J X Y ')
60 FORMAT(1X,I7,8(1X,F6.4))
90 FORMAT(2X,'=====')
61 FORMAT(1X,I4,2(2X,F9.6))
71 FORMAT(1X,I4,11X,2(2X,F9.6))
62 FORMAT(7X,'ERROR =',2(1X,F9.6))
72 FORMAT(3X,'# ITERATIONS =',I7)
63 FORMAT(7X,'ENTROPY =',2(1X,F9.6))
STOP
END

```

LIST OF REFERENCES

- [1.] Lawson, J. "An Elementary Theory of Surveillance," Naval Electronics System Command, Technical Report, Aug. 1978.
- [2.] Betsekas, D. P., Tsitsiklis, J. N. and Athans, M., "Convergence Theories of Distributed Iterative Process: A Survey," Laboratory of Information and Decision Systems, MIT, Report No. LIDS-P-1342, Dec. 1983.
- [3.] Yemini, Y. and Lazer, A., "Towards Distributed Sensor Networks, an Extended Abstract," *Proceedings of Information Sciences and Systems*, 1982, pp. 198-302.
- [4.] Lauer, G., and Sandell, N. R. "Distributed Detection of Known Signal in Noise," Report 160, ALPHATECH, Burlington, Mass., Mar. 1982.
- [5.] Tenney, R. R., and Sandell, N. R. "Detection with Distributed Sensors," *IEEE Trans. on Aerospace and Electronic Systems*, vol. ASE-17, 4, Jul. 1981, pp. 501-510.
- [6.] Van Trees, H. L., *Detection, Estimation, and Modulation Theory-Part I*, Wiley and Sons, New York, 1969.
- [7.] Sarma, V. V. S., and Rao, K. A. Gopala, "Decentralized Detection and Estimation in Distributed Sensors Systems," In *Proceedings of the IEEE Cybernetics and Society Conference*, vol-1, 1983, pp. 438-441.
- [8.] Chair, Z., and Varshney, P. K., "Optimal data fusion in multiple sensor detection systems," *IEEE Transaction on Aerospace and Electronic Systems*, vol. AES-22, 1, Jan. 1986, pp. 98-101.
- [9.] Reibman, A. R. and Nolte, L. W. "Optimum Detection and Performance of Distributed Sensor System," *IEEE Transaction on Aerospace and Electronic Systems*, vol. AES-23, 1, Jan. 1987, pp. 24-30.
- [10.] Ekchian, L. K., *Optimal Design of Distributed Detection Networks*, Ph.D. Dissertation, MIT, Sep. 1982.
- [11.] Ekchian, L. K. and Tenney, R. R., "Detection Networks," *Proceedings of the 21st Conference on Decision and Control*, 1982, pp. 686-691.

- [12.] Papastavrou, J. D. and Athans, M., "A Distributed Hypothesis-Testing Team Decision Problem with Communications cost," *Proceedings of the 25th Conference on Decision and Control*, Athens, Greece, Dec. 1986, pp. 219-225.
- [13.] C. H. Papadimitriou and K. Steiglitz, *Combinatorial Optimization: Algorithms and Complexity*, Englewood Cliffs, NJ: Prentice-Hall, 1982.
- [14.] Tsitsiklis, J. N. and Athans, M., "On the Complexity of Decentralized Decision Making and Detection Problems," *IEEE Trans. on Automatic Control*, vol. AC-30, No.5, May 1985, pp. 440-446.
- [15.] Kovatana, T., "Theoretical analysis of instruction alarm using two complementary sensors," Final Technical Report, Stanford Research Institute, Menlo Park, Calif., Feb. 1973.
- [16.] Fefjar, A., "Combining techniques to improve security in automated entry control," In *Proceedings of the 1973 Carnahan Conference on Crime Countermeasures*, May. 1978.
- [17.] Stearns, S. D., "Optimal detection using multiple sensors," *Proceedings of Carnahan conference on security technology*, Uxington, KY, USA, 1983.
- [18.] Max, J., "Quantization for Minimum Distortion," *IRE Trans. on Inform. Theory*, vol. IT-6, 1960, pp. 7-13.
- [19.] Pearson, C. E., *Numerical Methods in Engineering and Science*, Van Nostrand Reinhold Company, New York, 1986, pp. 11-12 and 49-50.
- [20.] Wozencraft, J. M. and Jacobs, I. M., *Principles of Communication Engineering*, Wiley, New York, 1967.
- [21.] E. K. Al-Hussaini and A. M. Al-Bassiouni, "Performance of an ideal switched diversity receiver for NCFSK signals with Nakagami fading," *Trans. IECE Japan*, vol. E65, Dec. 1982, pp. 750-751.
- [22.] E. K. Al-Hussaini and A. M. Al-Bassiouni, "Performance of MRC diversity Systems for the detection of signals with Nakagami fading," *IEEE Trans. on Commun.* vol. COM-33, No. 12, Dec. 1985, pp. 1315-1319.
- [23.] Lloyd, S. P., "Least Squares Quantization in PCM," Unpublished Bell Laboratories manuscript, July, 31, 1957; also in *IEEE Trans. on Inform. Theory*, vol. IT-28, pp. 129-137, 1982.
- [24.] Moose, P. M. and Al-Bassiouni, A. M. "Solution of the Lloyd-Max Quantizer Parameters by the Method of Successive Substitution," Naval Postgraduate School Technical Report No. NPS 62-88-004.

- [25.] Anthony D. Walen, *Detection of Signal in Noise*, Academic Press, 1971, p. 366.
- [26.] Sandell, N R., Jr., Variaya, P. C. Athans, M. and Safonov, M. G., "Survey of Decentralized Control Methods for Large Scale Systems," *IEEE Trans. on Automatic Control*, vol ,AC-23, 1978, pp. 108-128.
- [27.] Yu-Chi Ho and K Al-Ching Chu, "Team Decision Theory and Information Structures in Optimal Control Problems- Part I," *IEEE Trans. on Automatic Control*, vol. AC-17, No. 1, Feb. 1972.
- [28.] Yu-Chi Ho and K Al-Ching Chu, "Team Decision Theory and Information Structures in Optimal Control Problems- Part I," *IEEE Trans. on Automatic Control*, vol. AC-17, No. 1, Feb. 1972.
- [29.] Yu-Chi Ho and Marcia P. Kastner, "Teams, Signaling and Information Theory," *IEEE Trans. on Automatic Control*, vol. AC-23, No. 2, April 1978, pp. 305-312.
- [30.] R. Srinivasan, "Distributed Rader Detection Theory," *IEE Proceedings*, vol. 133, F, No. 1, Feb 1986, pp. 55-60.
- [31.] David A. Castanon and Demosthenis Teneketzis, "Nonlinear Data Fusion," *Proc. 1982 MIT/ONR Workshop on Command and Control*, Monterey, CA, August 1982, pp. 224-230.
- [32.] G. S. Lauer, D. Teneketzis, D. A. Castanon and N. R. Sandell, Jr. "Recent Advances in Distributed Detection," *Proc. 1982 MIT/ONR Workshop on Command and Control*, Monterey, CA, August 1982, pp. 175-179.
- [33.] D. Teneketzis , "The Decentralized Quickest Detection Problem," In *proceedings of the 21st IEEE Conference of Decision and Control*, Fort Lauderdale, FL., 1982, pp. 673-679.
- [34.] Sophocles,J. Orfanidis, *Optimum Signal Processing, An Introduction*, MacMillan Publishing Company, 1985, p. 8.
- [35.] Tom M. Apostol, *Mathematical Analysis*, Addison-Wesley Publishing Company, 1974, p. 14.
- [36.] David G. Messerschmit, "Quantization for Maximum Output Entropy", *IEEE Trans. on Infor. Theory*, Sep. 1971, pp. 612.
- [37.] Gallagar, R., *Information Theory and Reliable Communication*, Wiely, 1969.
- [38.] Y. Bar-Shalom, "Tracking Methods in a Multitarget Environment," *IEEE Tran. Automat, Contr.*, vol. AC-23, Aug. 1978, pp. 618-626.

- [39.] D. B. Reid, "An Algorithm for Tracking Multiple Targets," *IEEE Trans. Automat. Contr.*, vol. AC-24, Dec. 1979, pp. 843-854.
- [40.] Helstrom, C. W., *Probability and Stochastic Processes for Engineers*, Macmillan Publishing Company, 1984, pp. 179-181.
- [41.] Kassam, S. A., "Optimal Quantization for Signal Detection", *IEEE, Trans. on Communication*, vol. COM-25, No. 5, May 1977, pp. 479-484.
- [42.] Wood, C. R., "On Optimum Quantization", *IEEE Trans. on Information Theory*, vol. IT-15, No.2, March 1969.
- [43.] Velichkin, A. I., "Optimum Characteristics of Quantizers," *Telecommunication Radio Eng. (USSR)*, vol. 18, Feb. 1963, pp.1-7.
- [44.] Garmash, V. A., "The Quantization of Signals with Non-uniform Steps," *Telecommunications*, No. 10, pp. 10-12, Oct., 1957.

INITIAL DISTRIBUTION LIST

		No. Copies
1.	Defense Technical Information Center Cameron Station Alexandria, VA 22304-6145	2
2.	Library, Code 0142 Naval Postgraduate School Monterey, CA 93943-5002	2
3.	Department Chairman, Code 62 Naval Postgraduate School Monterey, California 93943-5000	1
4.	Prof. Paul H. Moose, Code 62-Me Naval Postgraduate School Monterey, California 93943-5000	5
5.	Prof. John M. Wozencraft , Code 62-me 6560 Brookdale Dr Carmel, California 93943	1
6.	Prof. Donald P. Gaver Code 55-Gv Naval Postgraduate School Monterey, California 93943-5000	1
7.	Prof. Harriett B. Rigas Dept. of Electrical Engineering and System Science Michigan State University East Lansing, Michigan 48824	1
8.	Prof. Arthur L. Schoenstadt Code 53-Zh Naval Postgraduate School Monterey, California 93943-5000	1
9.	Prof. Charles W. Therrien Code 62-Ti Naval Postgraduate School Monterey, California 93943-5000	1
10.	Prof. Daniel C. Bukofzer Code 62-Bh Naval Postgraduate School Monterey, California 93943-5000	1
11.	Prof. Roberto Cristi Code 62-Cx Naval Postgraduate School Monterey, California 93943-5000	1

- | | | |
|-----|------------------------------------------------------------------------------------------------------------------------------------|---|
| 12. | Prof. Louis L. Scharf
Dept. of Electrical and Computer Engineering
University of Colorado
Boulder, CO 80309 | 1 |
| 12. | Prof. Richard A. McGonigal Code 0305
Naval Postgraduate School
Monterey, California 93943-5000 | 1 |
| 14. | Prof. Donald Trahan Code 53-Tn
Naval Postgraduate School
Monterey, California 93943-5000 | 1 |
| 15. | Prof. Richard Franke Code 53-Fe
Naval Postgraduate School
Monterey, California 93943-5000 | 1 |
| 16. | Prof. Carroll Wilde Code 53-Wm
Naval Postgraduate School
Monterey, California 93943-5000 | 1 |
| 17. | Mr. Larry Frazier code 0141
Naval Postgraduate School
Monterey, California 93943-5000 | 1 |
| 18. | Prof. Emad K. Al-Hussaini
EE Dept., Faculty of Engineering
P.O. 15551, UAE University. Al-Ain
United Arab Emirates | 1 |
| 19. | Prof. Abdel-Wahaab Fayez
Faculty of Engineering, Cairo University
Giza, Egypt | 1 |
| 20. | Prof. P. K. Varshney
Electrical and Computer Engineering Department
111 Link Hall, Syracuse University
Syracuse, NY 13210 | 1 |
| 21. | Dr. Dave Harris L-205
Lawrence Livermore NTL Laboratory
P.O. Box 808
Livermore, CA 94550 | 1 |
| 22. | Chief, Research and Advancement Authority
Egyptian Armed Forces Headquarters
Nasr City, Cairo, Egypt | 1 |
| 23. | Chief, Armament Authority
Armament Authority of Egyptian Armed Forces
Koprey El-qubaa, Cairo, Egypt | 1 |

24. Chief, Training Authority 1
Egyptian Armed Forces Headquarters
Nasr City, Cairo, Egypt
25. Director, Signal Corps 1
Egyptian Armed Forces Headquarters
Nasr City, Cairo, Egypt
26. Library, Military Technical College 1
Koprey El-qubaa
Cairo, Egypt
27. Library, Faculty of Engineering 1
Cairo University
Giza, Egypt
28. Lieutenant Sarfraz Hussain 1
1577/18 Samnabad
Karachi, Pakistan
29. Mr. Seah Moon Ming 1
Blk. 1F, Gillman Heights #10-51
Republic of Singapore
30. Brigadier General Magdy G. El-Sheimy 1
317, King Faesal St., Madkor Station, Pyramid
Giza, Egypt
31. Colonel Salah M. El-Magraby 1
Building 38, Apt. 21, Tawfeek City.
Nasr City, Cairo, Egypt
32. Colonel Abdel-Moniem E. Doma 1
45, Ibraheim Abdel-Razik St.
Ein Shams, Cairo, Egypt
33. Colonel Mohamed M. Abdel-Moniem 1
45, Ibraheim Abdel-Razik St.
Ein Shams, Cairo, Egypt
34. Colonel Ismaeel A. Al-Getani 1
52, Bochary St., Enterance 2, Apt. 5
The New, 7(th) Area
Nasr City, Cairo, Egypt
35. Colonel Refat M. El-Hefny 1
23, High Industrial Institute St.
Ein Shams (east), Cairo, Egypt
36. Colonel Abdel Aziz M. Al-Bassiouni 5
1 Hamazeen St.
Kafrel Zaiat, Egypt

Thesis
A3347
c.1

Al-Bassiouni
Optimum signal process-
ing in distributed sensor
systems.

Thesis
A3347
c.1

Al-Bassiouni
Optimum signal process-
ing in distributed sensor
systems.



thesA3347

Optimum signal processing in distributed



3 2768 000 80285 4

DUDLEY KNOX LIBRARY